

*An Online CPD Course
brought to you by
CEDengineering.ca*

Fire Protection Systems

Course No: M04-051
Credit: 4 PDH

Elie Tawil, P.E., LEED AP

CED CANADA
engineering.ca
CPD FOR THE PROFESSIONAL

Continuing Education and Development, Inc.

P: (877) 322-5800
info@cedengineering.ca

This course was adapted from the Naval Education and Training Professional Development and Technology Center, Publication No. NAVEDTRA 14259A, "Utilitiesman Advanced", which is in the public domain.

1.0.0 INTRODUCTION

Suppose there was fire in a building that was unoccupied and no one was in the area to report it. The building could be severely damaged or completely destroyed before the fire department could respond. However, if this same building had a fire suppression system installed in it, the system would control or put out the fire and signal the fire department. Today, more and more buildings are being equipped with fire sprinkler systems. Part of your job is to install and then keep these systems operating. To do this, you need to know the types of systems and how they work.

2.0.0 AUTOMATIC SPRINKLER SYSTEM CHARACTERISTICS

Automatic sprinkler systems automatically distribute water upon a fire in sufficient quantity to either extinguish the fire or prevent its spread. All sprinkler systems have three basic components. They are a water supply, a piping network to carry the water, and sprinklers that distribute the water.

2.1.0 Types of Sprinkler Systems

There are several types of sprinkler systems. The most common ones are the wet pipe, the dry pipe (that uses the differential dry pipe valve, the low-differential dry pipe valve, or the mechanical or latched-clapper dry pipe valve), the water deluge, the pre-action, and the combined systems.

2.1.1 Wet pipe System

The wet pipe sprinkler system (*Figure 4-1*) is the most common type. This system has automatic sprinklers attached to a piping network that is under pressure at all times. The sprinklers are actuated by the heat of a fire. A wet pipe system is generally used when there is no danger of the water in the pipes freezing or when there are no special conditions that require a special purpose sprinkler system.

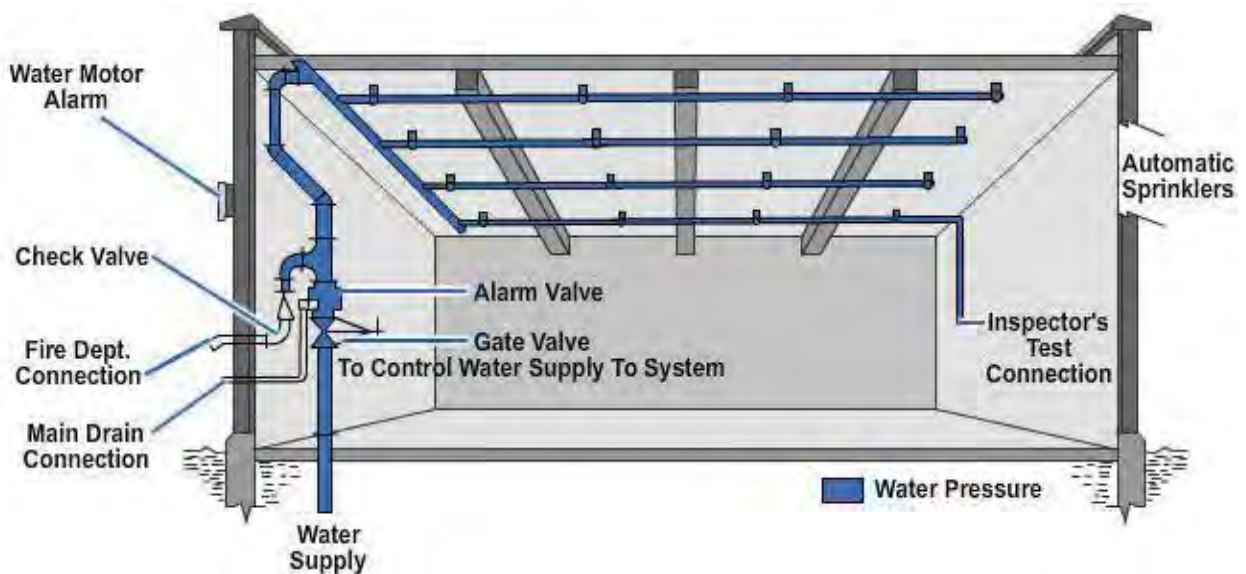

Figure 4-1 – Wet pipe sprinkler system.

The wet pipe sprinkler system may have an alarm check valve (*Figure 4-2*). This device is used to maintain a constant pressure on the system piping network above the valve. When there is a fire, the flowing water causes the **clapper** assembly inside the alarm check valve to open. This permits a portion of the water to flow through a port in the valve that is connected to an alarm device. To prevent false alarms, you can place a retard chamber in the piping between the alarm check valve and the alarm device.

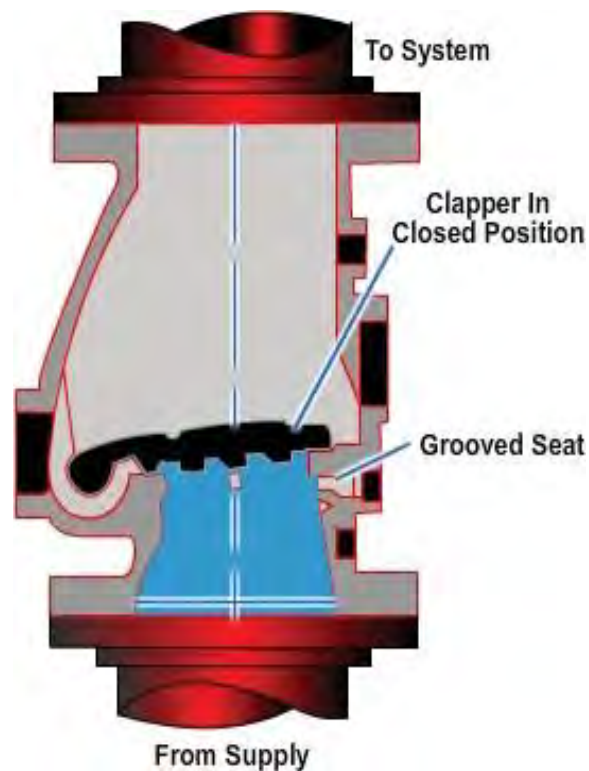

Figure 4-2 – Wet pipe system alarm check valve.

2.1.2 Dry Pipe System

In a dry pipe system (*Figure 4-3*), the pipes normally contain either air or nitrogen under pressure. Dry pipe systems are used in areas where the water in the pipes is subject to freezing.

A dry pipe valve acts as a control between the water supply and the air under pressure in the piping network. The dry pipe valve must be in a heated enclosure because pressurized water is at the underside of the valve. A small amount of water, called **priming water**, is also inside the dry pipe valve itself to ensure a tight seal of the clapper and to keep the rubber gaskets pliable. The valve is usually made so that a moderate air pressure holds back a much greater water pressure. There are several types of dry pipe valves.

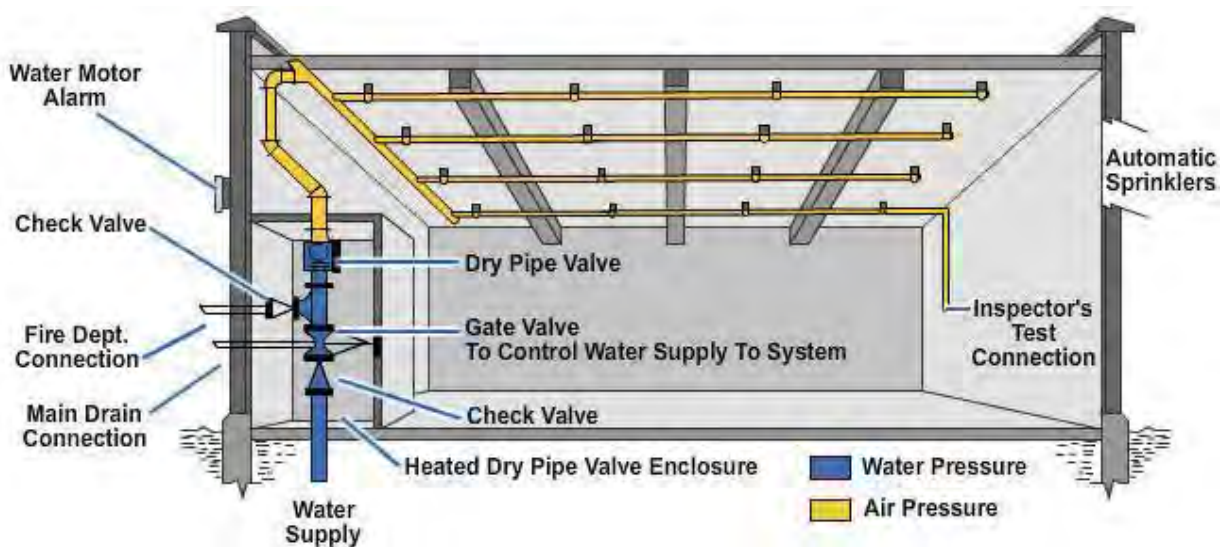

Figure 4-3 – Dry pipe sprinkler system.

2.1.2.1 Differential Dry Pipe Valve

The differential dry pipe valve (*Figure 4-4*) has a large clapper on the air side that bears directly on a smaller water side clapper. The differential between the areas of the two clappers is approximately 6 to 1. Therefore, relatively low air pressure can hold back a much larger water pressure. For example, 30 pounds per square inch (psi) air pressure can hold back 180 psi water pressure.

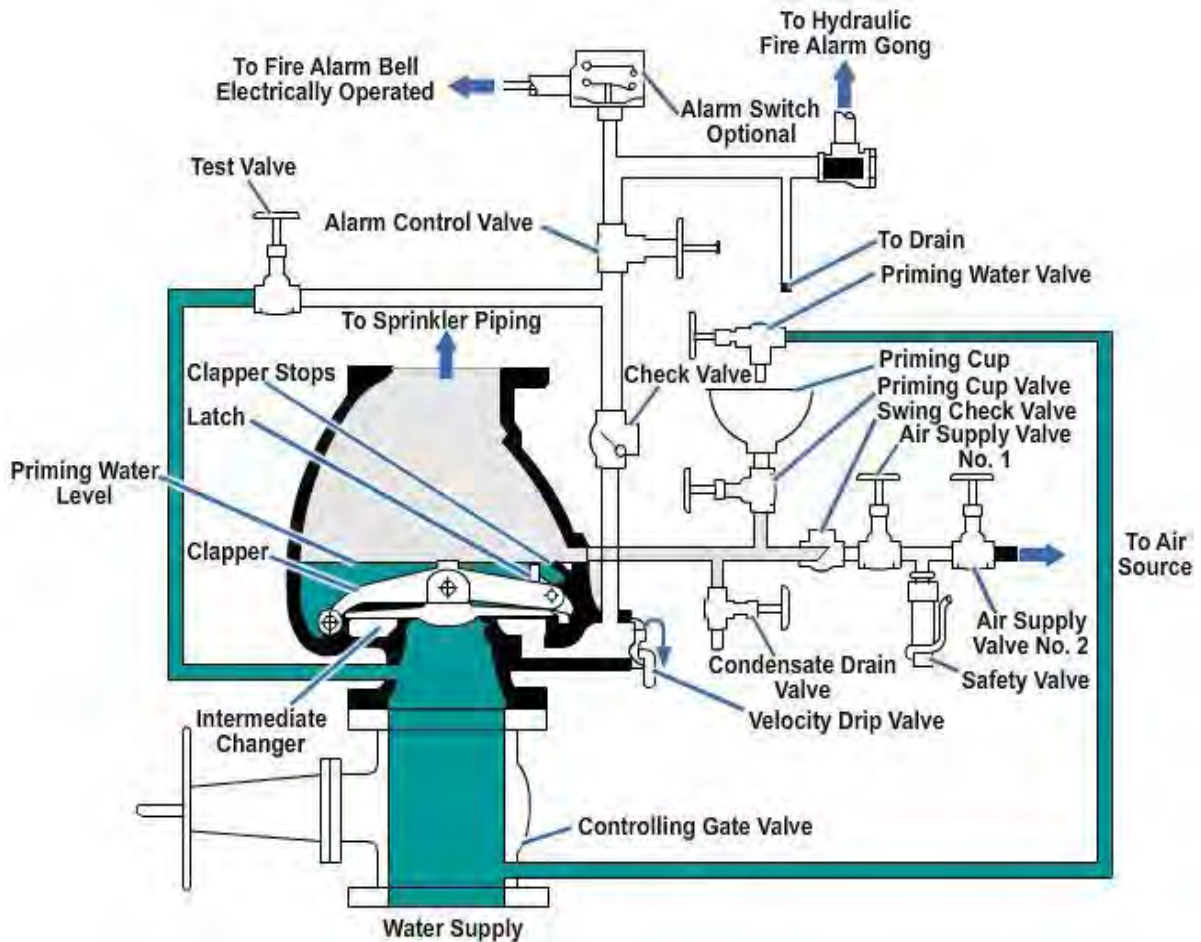

Figure 4-4 – Differential dry pipe valve.

To eliminate an accidental trip of the valve and false alarms, air pressure should be maintained at least 20 psi greater than the calculated trip pressure of the dry pipe valve. This is based on the highest normal water pressure of the supply system.

In operation, when there is a fire the heat actuates the sprinklers and allows the air pressure to be relieved from the piping network. The differential is destroyed. The water pressure below the valve opens the clapper, allowing water to flow through the piping to the open sprinklers. This operation has an inherent time delay between the actuation of the sprinklers and the application of water to the fire. This delay can be shortened by adding an accelerator or an exhauster to the dry pipe system.

The **accelerator** (*Figure 4-5*) allows air from the system's piping to enter the intermediate chamber in the dry pipe valve, destroy the differential, and open the clapper.

The **exhauster** (*Figure 4-6*) opens and exhausts air from the piping system faster than through the sprinklers, destroying the differential sooner.

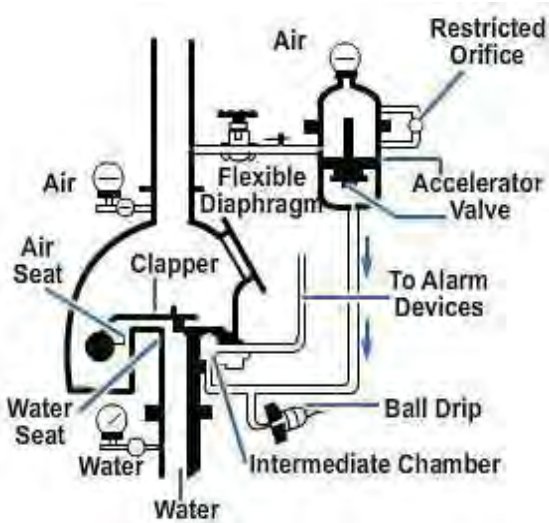

Figure 4-5 – Dry pipe system accelerator.

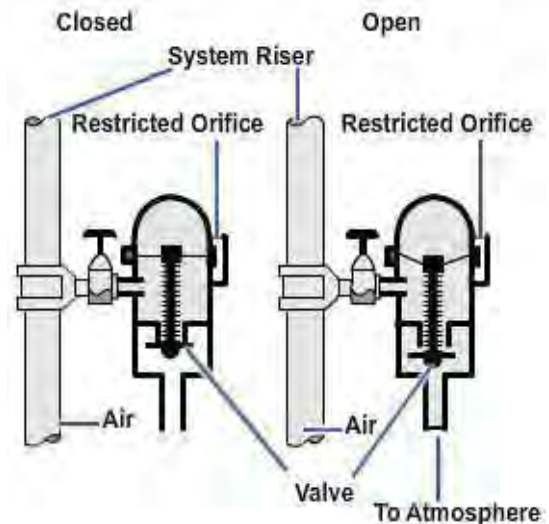

Figure 4-6 – Dry pipe system exhauster.

2.1.2.2 Low-Differential Dry Pipe Valve

Occasionally the water supply to dry pipe valves contains debris. With a Low-differential dry pipe valve, there is a high velocity of water entering the system when the valve trips. This velocity of water can carry debris into the system and cause the system to become blocked. If debris in the water is a problem, the low-differential dry pipe valve may be useful.

The clapper in the low-differential dry pipe valve is only slightly larger on the air side than on the water side. The air pressure in the system is maintained approximately 15 to 20 psi greater than the water pressure. Because the sprinkler system piping contains air pressure about equal to the water pressure, the sudden rush of water is slowed and only a slight amount of water is diverted into the branch lines, which do not have operating sprinklers after the valve opens.

With either a differential or low-differential dry pipe valve, an automatic air maintenance device must be used to maintain air pressure and prevent accidentally tripping the dry pipe valve. Also, an automatic drain or high-water level alarm is required for the priming water level so the water does not accumulate. (If there is too much priming water, the valve cannot operate.)

2.1.2.3 Mechanical or Latched-Clapper Dry Pipe Valve

The mechanical or latched-clapper dry pipe valve (*Figure 4-7*) operates under the same theory as other dry pipe valves. It has system air pressure against a small disk, diaphragm, or clapper. An arrangement of levers, links, and latches on the valve clapper provides the leverage for the closing force placed on the water clapper.

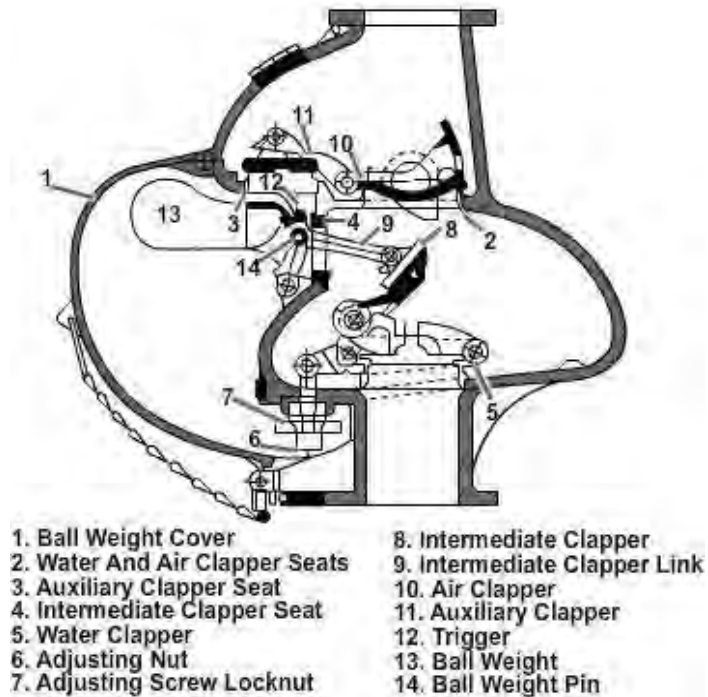

Figure 4-7 – Mechanical dry pipe valve.

2.1.3 Water Deluge System

A water deluge system (*Figure 4-8*) is used where there is an extra hazard, such as areas where flammable liquids or propellants are handled or stored, or where there is a possibility that a fire might grow faster than ordinary sprinkler systems can control. These systems are also often used in aircraft hangars where ceilings are unusually high and where drafts may deflect the direct rise of heat so that sprinklers directly over the fire would not open promptly but others, at some distance away, might open without having any effect on the fire.

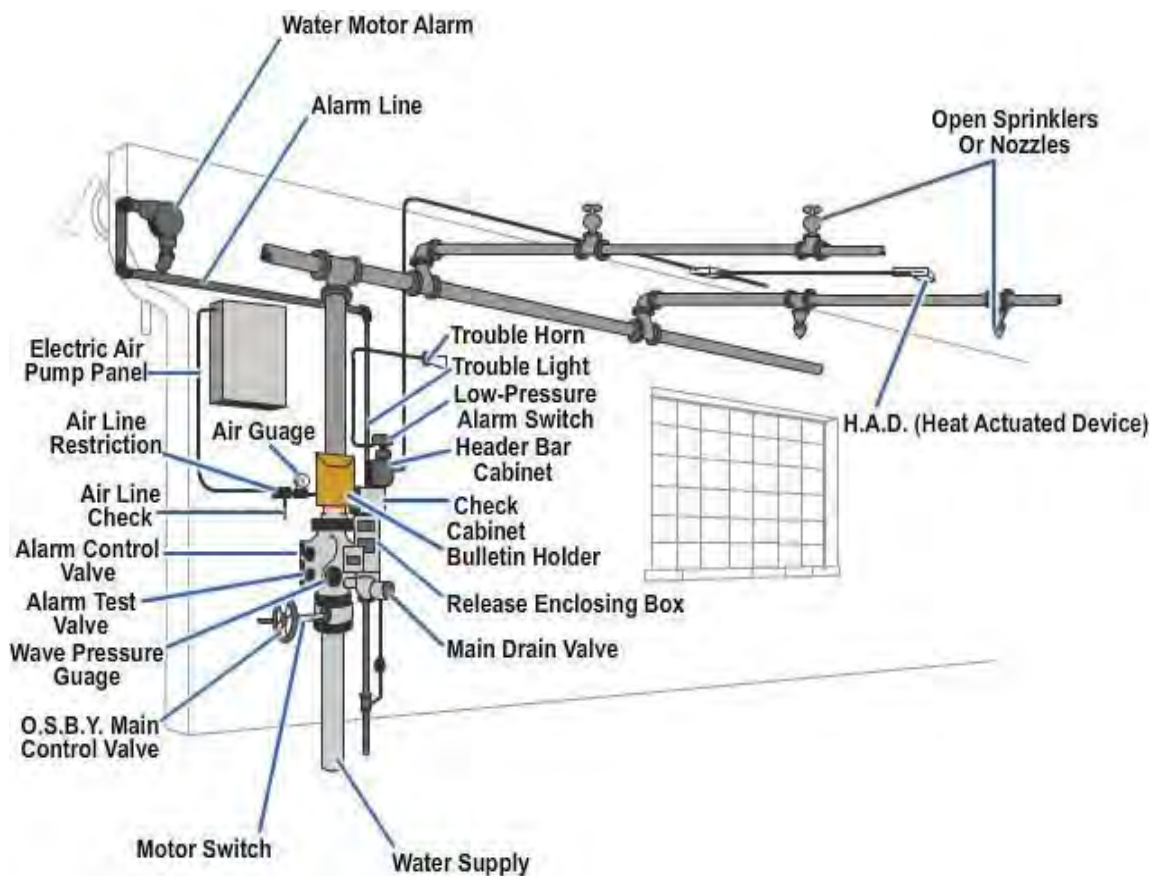

Figure 4-8 – Water deluge system.

In the water deluge system, all sprinklers connected to the piping network are open and the water supply is controlled by a water deluge valve (*Figure 4-9*). The water deluge valve remains closed until a fire is detected by a heat-actuated device that in turn causes the valve to open. Heat actuated devices (HAD) can be either mechanical or electrical in operation. They are discussed in further detail later in this chapter.

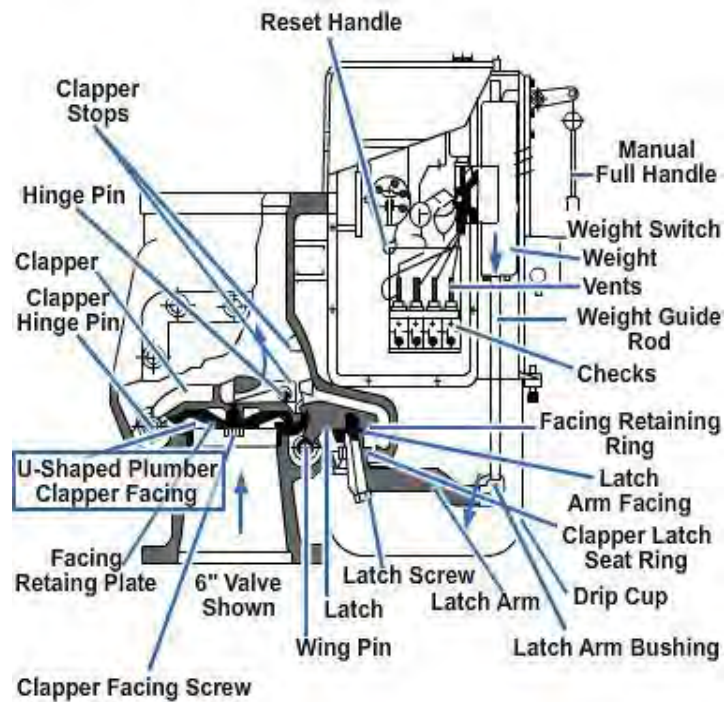

Figure 4-9 – Deluge valve.

The deluge system has a time delay between detection of a fire and the discharge of water at the sprinkler heads. This delay is due to the time required to operate the valve and fill the piping network with water, similar to the dry pipe system. To reduce the delay, the deluge system may be preprimed by filling the piping network with water downstream from the deluge valve. To prevent water from escaping from the sprinklers, pre-prime plugs (*Figure 4-10*) are placed on the sprinklers. These plugs blow out of the sprinklers at approximately 20 psi water pressure.



Figure 4-10 – Sprinkler pre-prime plugs.

2.1.4 Pre Action System

A pre-action system differs from a deluge system only in that it has automatic sprinklers that are normally closed. When the fire detecting device is actuated, the water control valve opens and admits water into the piping system. The system then acts the same as a wet pipe system. Individual sprinklers are opened by the heat of the fire. The advantage of the pre-action system is that the probability of inadvertent water discharge is minimized because operation of both the detection system and automatic sprinklers is necessary for discharge of extinguishing water.

It is incorrect to refer to pre-action systems as dry pipe sprinkler systems. It is true that the pre-action system piping does not contain water. However, the term dry pipe system refers to the type of sprinkler system and the type of water control valve that operates the system.

There are two types of pre-action systems. The first system is the supervised system, which has air introduced into the system piping at a pressure of approximately 5 psi. This air pressure supervises the piping to detect leaks. The pressure switches used for detection of low air pressure on the supervised system should record in inches of water rather than pounds per square inch. The second system is the unsupervised pre-action system. It has no means of continuous monitoring.

2.1.5 Combined System

A combined system (*Figure 4-11*) is a special purpose arrangement using two modified dry pipe valves connected to tripping devices and piped in parallel to supply water to the same sprinkler system. The piping network is filled with air under pressure. When a fire is detected, an exhauster at the end of the system opens and releases the air within the system. The system then operates the same as a pre-action system. However, if the detection system fails, the combined system acts the same as a dry pipe system and allows water to be admitted to the system when the sprinklers open, discharging the air from the piping network.

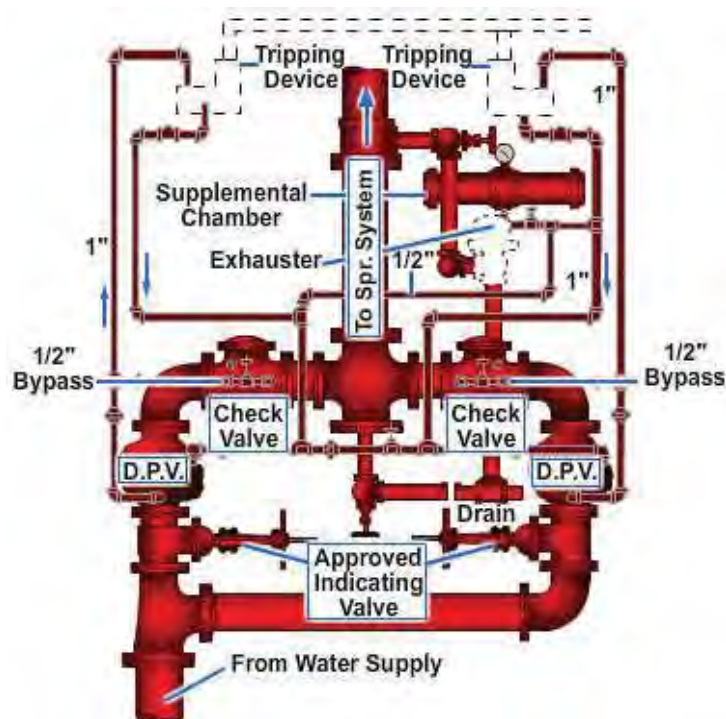

Figure 4-11 – Combined system header arrangement.

2.2.0 Types of Sprinklers

Sprinklers are nozzles placed at intervals along the piping network to distribute a uniform pattern of water on the area being protected. To attain maximum efficiency, the stream of water must be broken into droplets. A deflector (part of the frame of the sprinkler) breaks up the water.

You, as a UT, will generally install sprinklers to meet the specifications and plans of a project. When you require more information on the proper locating of sprinklers, refer to the National Fire Protection Association Code Book Number 13 (NFPA #13), entitled Installation of Sprinkler Systems.

Automatic sprinklers are designed for specific applications based on orifice size, deflector design, frame finish, and temperature rating. Sprinklers have orifices ranging in size from 1/4-inch to 1/2-inch diameter graduated by 1/16-inch increments. There is also one 17/32-inch size orifice. Deflectors give different patterns of water distribution and allow the sprinkler to be placed in various locations, such as upright, pendent, or sidewall (*Figure 4-12*).

Next, sprinkler frames may be plated for appearance or they may be coated for protection from an adverse environment. For example, sprinklers that will be used in corrosive atmospheres are either lead- or wax-coated. Finally, automatic sprinklers are normally held closed by heat-sensitive elements that press down on a cap over the sprinkler orifice and are anchored by the frame of the sprinkler. The heat-sensitive elements melt and release at different temperatures, depending on application. Sprinklers are color coded to identify the temperature range rating of the fusible element (*Table 4-1*). Color coding is not required for plated sprinklers, ceiling sprinklers, or similar decorative types.

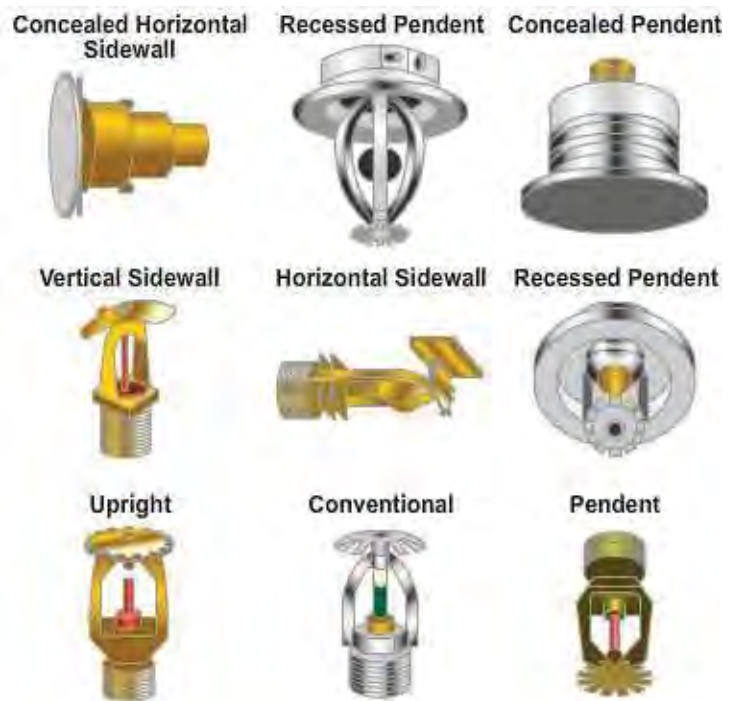

Figure 4-12 – Different styles of sprinkler deflectors.

Table 4-1 – Sprinkler temperature ratings.

Maximum Ceiling Temperature (°F)	Temperature Rating (°F)	Temperature Classification	Sprinkler Color Code
100	135-170	Ordinary	Uncolored
150	175-225	Intermediate	White
225	250-300	High	Blue
300	325-375	Extra High	Red
375	400-475	Very Extra High	Green
475	500-575	Ultra High	Orange
625	650	Ultra High	Orange

There are basically four types of release mechanisms for automatic sprinklers. They are the fusible link, frangible bulb, frangible pellet, and bimetallic element.

The fusible link sprinkler (*Figure 4-13, A*) is kept closed by a two-piece link held together by a solder with a predetermined melting point. When the solder melts, the levers pull the two-piece link apart and fly away from the sprinkler. Pressure in the piping network pushes the cap from the orifice of the sprinkler to discharge water.

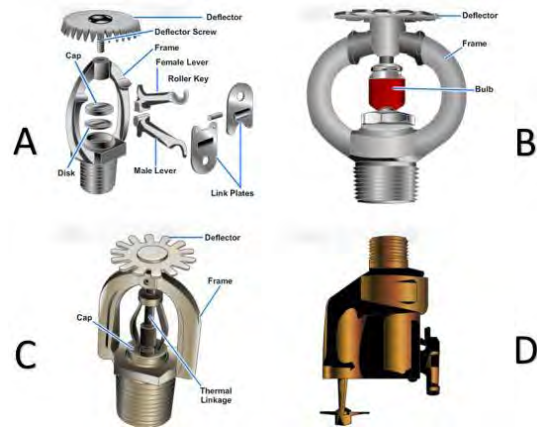

The frangible bulb sprinkler (*Figure 4-13, B*) has a small bulb made of glass between the orifice cap and the sprinkler frame. The bulb is partially filled with a liquid. Air fills the remaining space. Heat from a fire will cause the liquid to expand against the air, causing the glass bulb to shatter and opening the sprinkler for water discharge.

A frangible pellet sprinkler (*Figure 4-13, C*) has a rod between the orifice cap and sprinkler frame. The rod is held in place by a pellet of solder under compression. When the solder melts, the rod moves out of the way of the orifice cap. The cap is pushed off by the water pressure in the piping network.

Figure 4-13 – Types of automatic sprinklers.

The bimetallic element sprinkler (*Figure 4-13, D*) uses a disk made of two distinct metals as a heat-sensitive element. When the sprinkler is off, the disk maintains pressure on a piston assembly. When a fire occurs and the temperature reaches the sprinkler's rating, the disk flexes and opens, releasing pressure on the piston assembly and allowing a small amount of water to bleed out of the piston chamber faster than it can be replaced through a restrictor. The water pressure in the piping network pushes the piston down and allows water to discharge from the sprinkler. When the temperature of the heat-sensitive element is reduced, the element returns to its normal position and allows water to pass through the restrictor, filling up the piston chamber, forcing the piston into the closed position, and stopping water discharge. This sprinkler can be used to automatically cycle on and off as necessary, for example, to put out a rekindled fire.

Other sprinkler heads that do not have release mechanisms include the dry pendent sprinkler, the open sprinkler, and water spray nozzles.

A dry pendent sprinkler (*Figure 4-14*) is used when pendent sprinklers must be placed on dry pipe systems or in wet pipe systems when the area to be protected is subject to freezing, such as a walk-in reefer or outside shop area, and the piping network is installed in a heated area. This sprinkler is fitted with a tube within an attached pipe. The tube holds the water-sealing elements in place against a watertight seal at the top of the pipe. When the sprinkler is actuated, the tube drops down and releases the elements through the tube and out the open sprinkler with the water discharge.



Open sprinklers consist only of a sprinkler frame and deflector. They are used on special sprinkler systems, such as deluge or rapid reaction systems (*Figure 4-15*).



Figure 4-15 – Open sprinkler.

Figure 4-14 – Dry pendent automatic sprinkler.

Water spray nozzles (Figure 4-16) are used for special application of water in various patterns, for example, wide or narrow angle, long throw, or flat patterns. The different patterns may be achieved by either internal or external deflection of the water stream, depending on the type of nozzle.

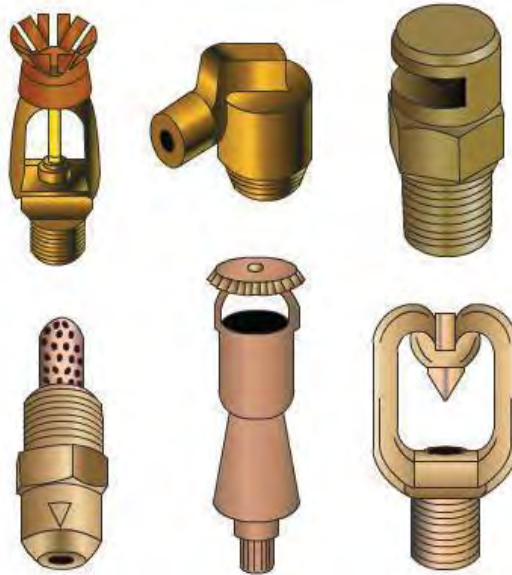

Figure 4-16 – Water spray nozzles.

2.3.0 Sprinkler System Detection and Indicating Devices and Fittings

Sprinkler systems have many different controlling devices and fittings. These can be classified as detecting or initiating devices or fittings. Their function is to detect system operation and to initiate system operation or alarm systems connected to the sprinkler system. This section discusses these devices and fittings to aid you in installing and troubleshooting sprinkler systems and understanding the interface between the mechanical and electrical functions of these devices.

2.3.1 Water Flow Actuated Detectors

Sprinkler water flow detectors are generally pressure actuated or vane actuated. Pressure switches are used on both wet and dry pipe systems. Vane switches are widely used on wet pipe sprinkler systems. They cannot be used on dry pipe systems because the initial rush of water into the pipe could damage the vane and mechanism.

Dry pipe system alarms tend to be slow acting because it takes time to lose sufficient air through a fused sprinkler to trip the system. Various methods are used to speed up dry pipe systems, as discussed earlier.

Wet pipe system alarms have a different problem. Fluctuating water pressure frequently causes flow into a sprinkler system, equalizing the sprinkler system pressure with the supply pressure. Such surges of water or of pressure cause false water flow alarms if some method of slowing down the switch response to the surge is not used. Various retarding techniques are used, some associated with the sprinkler piping and some with the water flow detector.

The pressure increase type of water flow detector (*Figure 4-17*) comes in numerous styles. It is found in wet or dry pipe sprinkler systems. The usual arrangement for switch actuation includes a sealed, accordion-like bellows that is assembled to a spring and linkage. The spring-tension setting controls the pressure at which the flow detector is actuated. It can be field adjustable and/or factory set to the desired pressure that activates the electrical switch. If this pressure switch is to be used on a wet pipe system, it is usually mounted at the top of a retarding chamber. This reduces the speed of pressure buildup at the switch. Other styles of this switch incorporate a pneumatic retarding mechanism within the detector housing. The retard time is adjustable to a maximum of 90 seconds. Usual settings are in the range of 20 to 70 seconds. The retard switch is connected to the alarm port of a wet sprinkler system alarm check valve. It is usually set for a pressure range of 8 to 15 psi.

Pressure drop detectors can be used in wet pipe sprinkler systems equipped with a check valve (alarm check or swing check) that holds excess pressure on the system side of the check valve. These detectors are frequently used where a water surge or hammer causes false alarms with other types of water flow detectors. The construction of pressure drop detectors is similar to the pressure increase detectors. The switch for a pressure drop detector is arranged to actuate on a drop in pressure. There is no retarding mechanism or chamber. A typical switch of this type is adjusted for a normal operating pressure in the range of 50 to 130 psi. The alarm pressure is adjustable between 10 to 20 psi below normal pressure.

A vane type of water flow detector (*Figure 4-18*) is used only in wet pipe sprinkler systems. The detector is assembled at the pipe by drilling a hole in the wall of the sprinkler pipe, inserting the vane into the pipe, then clamping the detector on with U-bolts. When the sprinkler system is actuated by fire, the water flowing through the pipe causes the vane to move. A mechanical linkage connects the vane to an adjustable retarding device, usually a pneumatic dashpot. The retarding device actuates the alarm switch or switches and/or signal transmitter. The retarding device setting is usually in the range of 30 to 45 seconds. A maximum setting may be as high as 90 seconds, if necessary.

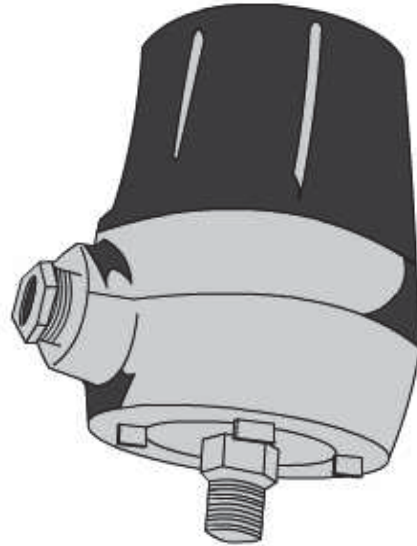

Figure 4-17 – Pressure increase type of water flow detector.

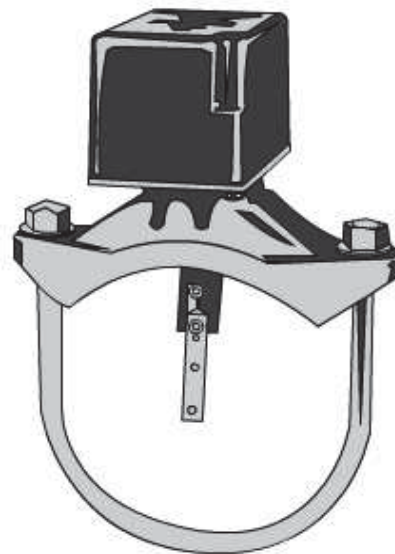

Figure 4-18 – Vane type of water flow detector.

The pressure pump/pressure drop type of water flow detector is used in large sprinkler systems and in those systems with inadequate water pressure to operate reliably one of the other types of water flow detectors. These detectors are also known as fixed-pressure, water flow detectors with pump (*Figure 4-19*). This detector has a pump, pump motor, and control unit. It is arranged for strap-mounting to the sprinkler system riser. The device provides a water flow alarm signal, a low system water pressure supervisory signal, and excess pressure in the system to prevent surges in the supply pressure from opening the alarm check valve and causing operation of the water motor gong or other alarm indicators.

A typical detector of this type is adjusted to maintain the system pressure at 25 to 50 psi above supply pressure. A slow leak at the alarm check valve or anywhere in the system will cause the system pressure to drop slowly. When pressure decreases to 2 psi below the preset value, a pressure switch closes, causing the pump to start pumping water from the supply side to the system side of the alarm check valve at a rate of about 1 gallon per minute (gpm). If the total system leaks less than 1 gpm, the pressure switch opens and stops the pump when the preset pressure is reached. However, if the system leaks are greater than 1 gpm, system pressure will continue to drop even with the pump running. If system pressure decreases to 4 psi below the preset value, a trouble pressure switch opens to indicate that there is a leak greater than 1 gpm. If the water pressure continues to drop to 6 psi below the preset value, an alarm pressure switch closes, signaling a water flow alarm.

Some water flow detectors of this type have an additional switch that disconnects pump power when the supply water pressure drops below 14 psi. This prevents pump burn up in case of total supply shutdown or a break in the supply line.

The electronic pressure drop detector is often used in sprinkler systems that must maintain a high excess system pressure over supply pressure that would delay actuation of a vane type of water flow detector. It is normally mounted to the riser pipe with a flexible hose connection to the system side of the check valve. This device requires a pressure drop of 5 to 20 ounces per square inch, continuing over a period of at least 3 seconds to signal an alarm. A pressure drop at a slower rate or of a shorter duration causes no alarm. A slow pressure drop to 15 psi or less causes a trouble signal indicating a system leak and low supply pressure. Pressure increases do not cause an alarm, but an over pressure condition (200psi) causes a trouble signal. Trouble signals will also be initiated when the detector's cover is opened, supply voltage is outside normal ranges, and an internal circuit fails, interfering with detector function.

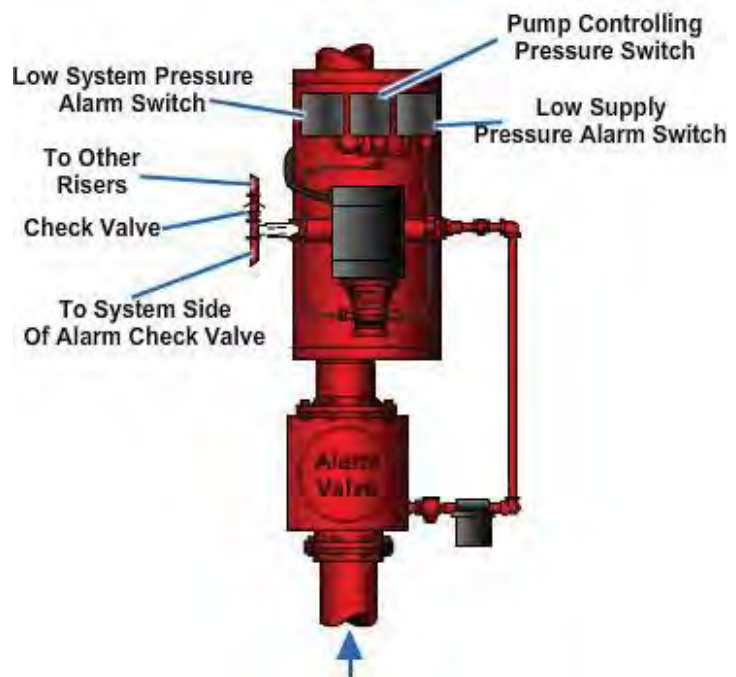

Figure 4-19 – Fixed-pressure water flow detector with pump.

2.3.2 Supervisory Initiating Devices

Supervisory alarm initiating devices cause a signal at the supervisory control unit and/or remote receiver when an abnormal fire protection system condition occurs. In general, supervised valves are never closed unless a sprinkler system requires maintenance. Valves that control water flow to a water flow detector or valves in a sprinkler header room or fire pump room that are normally closed may be supervised. Supervisory devices for normally open valves signal when the valve is closed no more than two turns or 20 percent of its total travel. Supervisory devices for normally closed valves signal when the valve is opened no more than two turns or 20 percent of its total travel.

Outside screw and yoke (OS&Y) valve position indicators are firmly attached to the valve yoke (*Figure 4-20*). The spring-loaded switch operating lever (*Figure 4-21, View A*) or plunger (*Figure 4-21, View B*) rests in a smoothly tapered notch in the valve stem. When the valve is operated, the stem moves in or out; the lever or plunger moves up the incline at the edge of the notch. The switch is actuated before the lever or plunger is out of the notch. This causes a supervisory signal at the control unit and/or remote receiver.

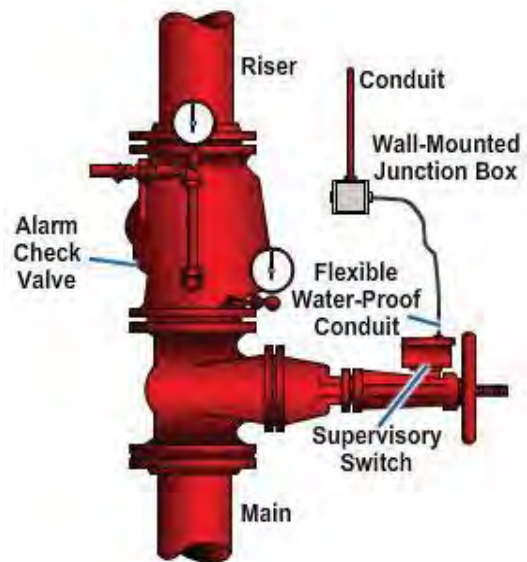
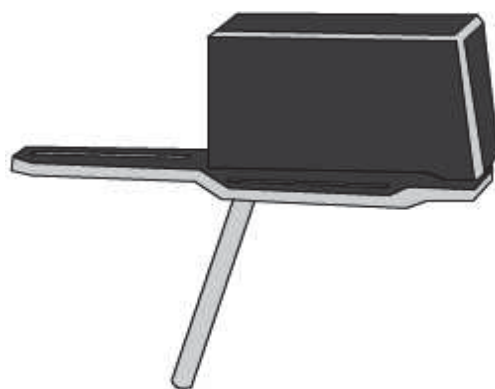
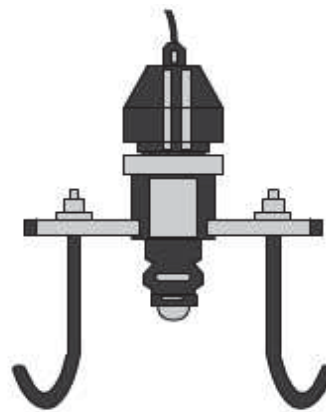

Figure 4-20 – OS&Y valve position supervisory switch location.



View A - Lever Type



View B - Plunger Type

Figure 4-21 – Lever and plunger type OS&Y valve position indicators.

A post indicator valve (PIV) will have a position indicator mounted to it (*Figure 4-22*). Usually a PIV is located outside the building and may be mounted on the ground or on the building wall. A spring-loaded lever rests against the side of the open/shut indicator, called a target. As the valve is operated, the target moves. The switch follows this movement. The position indicating switch is adjusted to cause a supervisory signal before the operating nut has rotated two turns or 20 percent of its full travel.

Nonrising stem valve position indicators are attached to nonrising stem valves, usually installed underground. The housing of the device is made of a non-corroding material, such as brass. The switch itself is a magnetically operated, sealed reed switch. As the valve is operated, the magnet moves away from the reed switch. After the valve has been opened two full turns, the magnet is far enough away from the reed switch to actuate it, causing a supervisory signal at the control unit and/or remote receiver.

Water level in sprinkler system reservoirs must be maintained within certain limits. There are usually automatic controls for maintaining the desired water level. Water level supervisory devices cause a supervisory signal when the water level is not maintained between the desired high and low limits.

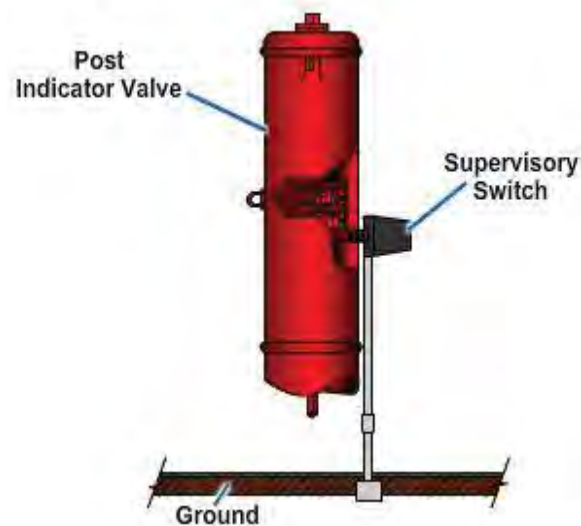

Figure 4-22 – Post indicator valve.

A float-actuated level indicator is mounted outside on the wall of a tank with its float and lever extended into the tank. The lever arm pivots at the tank wall and rises or falls with the water level. The lever arm pivots at the tank wall and rises or falls with the water level. A switch or switches (one for high level, one for low level) are actuated when the float moves outside normal limits. *Figure 4-23* shows a typical high-low water level supervisory device installed in a sprinkler system reservoir.

A pressure-actuated level indicator is physically very similar to the bellows-operated pressure switches used for water flow detection, as shown in *Figure 4-18*. As the water level changes in a reservoir, the water pressure at the supervisory switch also changes. The switch can be adjusted to actuate when pressure indicates a low water level or a high water level. This device is generally installed in the piping near the bottom of the reservoir.

Electronic level indicators may also be found in some systems. These indicators read the conductivity of water to cause an electrical signal. These devices are most frequently used to sense high water levels. They are not commonly used in fire protection systems.

Temperature supervisory devices are used to prevent water freezing in fire protection systems.

UTs will most commonly work with low water temperature indicators. These are usually sealed, factory-set thermostats and may be installed in system pipe or reservoirs. The most frequent low temperature setting is 40°F. *Figure 4-23* also shows a low water temperature indicator installed in a system reservoir.

You may find other supervisory devices in use. They will usually be specifically designed for a particular system. The principles of operation are generally the same as those already discussed. Physical mounting provisions or other details may vary. Refer to NAVFAC MO-117, manufacturer's manuals, and NFPA #13 for more complete information when you must install or maintain these devices.

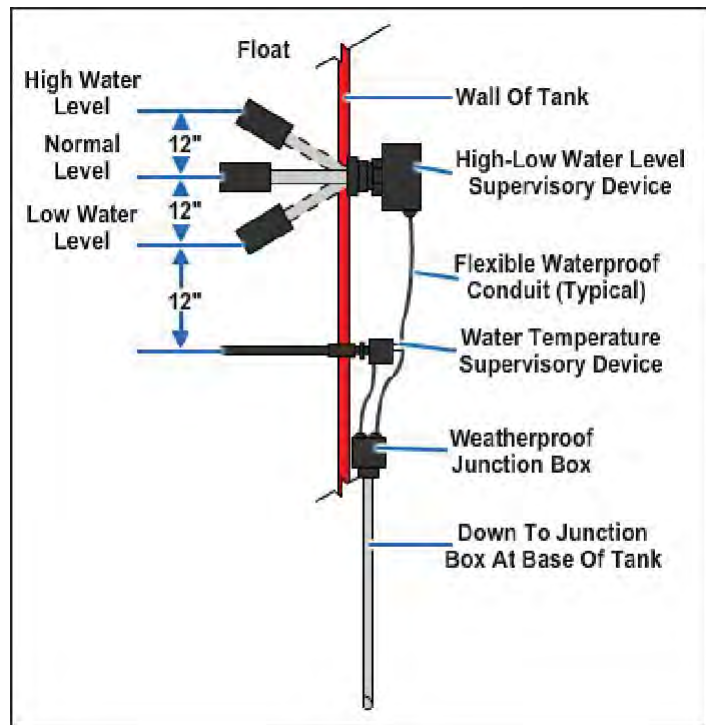

Figure 4-23 – Water level and temperature supervisory device mounted in tank.

Test your Knowledge (Select the Correct Response)

1. What type of automatic sprinkler system is most commonly used?
 - A. Wet pipe
 - B. Semidry pipe
 - C. Low-differential dry pipe
 - D. Latched-clapper dry pipe

3.0.0 WATER SUPPLY REQUIREMENTS

Water supplies that serve sprinkler systems must be adequate and reliable. To determine the amount of water necessary for a sprinkler system, the rate of flow and pressure needed for effective performance must be known. If additional fire hoses are to be connected to the outside of the building, these should also be included. The combined water needed for all fire-fighting equipment is known as the **fire flow demand**.

An adequate system can deliver the required fire flow for a specified time with normal water consumption at the maximum rate. To be reliable, the system must also be able to deliver the fire flow demand under certain emergency conditions, such as when a supply main or pump is out of service. The desired reliability of the system depends upon the nature of the protected structure (people, property, or mission). Water may be supplied by public or base sources, water tanks, or fire pumps.

For specific information regarding the fire flow demands of sprinkler systems, refer to NFPA #13, chapters 2, 7, and 8. These chapters will give you the information required for the sizing of each particular type of sprinkler system hazard based on residual pressure, acceptable flow rates, and duration times.

4.0.0 INSPECTION, TESTING, and MAINTENANCE REQUIREMENTS

Sprinkler systems, when properly installed, are an effective means of fire protection for life and property. To make sure these systems are reliable, periodic inspection and maintenance of system components are required. Inspection should include a visual check and, if possible, a test of the components to be sure a working condition exists. The frequency of the overall testing and inspection process is summarized in *Table 4-2*.

Table 4-2 – Summary of Inspection and Test Frequencies for Sprinkler Systems.

	Weekly	Monthly	Quarterly	Annually	Every 3 years
Check general condition of sprinklers and sprinkler system				X	
Conduct flow tests of open sprinklers				X	
Conduct main drain tests			X		
Test water flow alarms		X			
Check air and water pressure in dry pipe systems	X				
Trip test dry pipe valves				X	
Drain low points in dry pipe systems				X	
Trip test deluge and pre-action systems				X	X ¹
Trip test high-speed suppression systems					X
Check general condition of standpipe systems			X		
Perform water flow tests				X	
Check general condition of hydrants				X	
Check general condition of fire department connections				X	
Check water levels in tanks	X				
Check general condition of water storage tanks				X	
Check water level and air pressure in pressure tanks	X				
Check general condition of pressure tanks				X	
Check tank heating systems				X	
Inspect and test cathodic protection equipment				X	
Start fire pumps	X				
Check fuel supply to engine drivers	X				
Perform fire pump flow tests				X	
Inspect and test controllers				X	
Inspect valves for open position		X			
Conduct general preventive maintenance inspection of valves				X	
Inspect check valves, water flow meters, and backflow preventers					X ¹
Test pressure regulating and altitude valves				X	
1- Annual trip test may be dry: wet trip test including flow of water through heads/nozzles shall be conducted a minimum of once every 3 years.					

4.1.0 Inspection and Testing

During inspections of sprinklers, certain conditions indicate maintenance requirements. If these conditions are not corrected, they will reduce the reliability of the system. These conditions and some remedial actions are discussed in the following sections.

4.1.1 Automatic Sprinklers

Conditions that indicate the need for maintenance for automatic sprinklers include:

- Mechanical injury, such as bent or loose deflectors or bent frames. Where sprinklers are subjected to continual damage, provide approved sprinkler guards.
- Corrosion, such as marked discoloration or hard deposits. Use lead-coated or wax-coated sprinklers to prevent corrosion.
- Overheating, this causes soldered joints and cracked quartz bulbs to give way. Temperature ratings for soldered link sprinklers should be 50 °F above (for quartz bulb sprinklers, 25 °F above) normal room temperature.
- Freezing, which produces reduced tension in soldered links, bent struts, and distorted caps.
- Loading, or deposits of paint or other foreign materials.
- The need for replacement or relocation. Major construction and occupancy changes and changes to heating, lighting, and air-conditioning systems may require relocation or replacement of sprinklers or additions to the system. Changes in sprinkler location and pipe sizes should be based upon an engineering evaluation.
- A clearance of at least 18 inches under the sprinklers is necessary for proper water distribution where sprinklers are installed in areas where there is stockpiling of materials.

Keep a supply of extra sprinklers for the various types and temperature ratings required and a sprinkler wrench.

4.1.2 Outside Open Sprinklers

When you are servicing outside open sprinklers, you should do the following:

- Visually check the general condition of sprinklers.
- Close windows and doors and take proper precautions to avoid water damage to property before making flow tests.
- Conduct the flow test by opening the control valve.

After making flow tests, remove and clean any plugged or obstructed sprinklers.

4.1.3 Piping and Hangers

In servicing piping and hangers, check for mechanical injury and corrosion. Replace bent or damaged piping and fittings and replace or repair missing or loose hangers. Make sure that piping is not used to support stock, equipment, or other material.

Make sure wet pipe system piping is properly protected against freezing. Before and during freezing weather, check piping of dry pipe systems for proper drainage. During freezing weather, open drains for outside sprinkler systems. Drain water from low point drains and drum drips on dry pipe systems before freezing weather occurs.

4.1.4 Obstructed Piping

When evidence of obstruction of piping has been found, check for the following sources of obstructing material:

- Improperly screened inlets from open bodies of water
- Poorly maintained, elevated gravity tanks
- Dead end of extensive water distribution systems
- Poorly installed underground mains
- Highly acid, alkaline, or saline water
- Active chemicals in water supply
- Use of secondhand materials in the sprinkler system
- Frequent operation of systems (especially dry pipe systems) introducing additional foreign material and free oxygen

4.1.5 Alarm Check Valves

Perform a 2-inch drain test quarterly to test alarm check valves. Open the 2-inch drain valve fully and record pressure on the gauge located below the clapper at the lowest point. Close the 2-inch drain valve and record pressure at the stabilization point. Notice whether pressure returns quickly or slowly. Maintain a continuous record of drain tests. If recorded pressure when the valve is wide open is similar to previous recordings and pressure returns quickly, it is normal.

If recorded pressure when the valve is wide open is significantly lower or pressure is slow to return when the valve is closed, there may be an obstruction in the waterway. Check for the following problems:

- Partially closed valves to sprinkler system
- Obstruction in alarm valve preventing clapper from opening freely

Test local water flow alarm operation monthly by opening the test connection at the end of the system. Where there is no test connection, the alarm may be tested by opening the bypass valve to the circuit opener or closer or by opening the 2-inch drain valve about two and one-half turns. Do not test water motor alarms during freezing weather.

To find principal causes of alarm failures, check for the following:

- Failure of automatic drain on retard chamber to close
- Closed or partially closed valve on piping to alarm devices
- Plugging of bell casings of water motor gongs by foreign material
- Corrosion of moving parts of water motor gongs
- Detachment of shaft couplings from water motor gongs
- Insufficient water flow to operate devices
- Alarm check valve corroded shut (This failure is not common and will not occur when systems are properly maintained.)

To find principal causes of false fire alarms, check for the following:

- Improper drainage of retard chamber (correct by opening the chamber and cleaning or repairing the automatic drain)
- Pressure surges through the alarm check valve

Fill wet pipe sprinkler systems slowly through throttled valves and open the control valve wide after the system has been filled. Be sure there is no drainage from retard chambers. Leakage means that the alarm valve clappers are not seating properly. They require cleaning and possibly overhauling.

Make internal inspections of alarm valves when normal testing procedures indicate the need:

- Examine valve body for tuberculation.
- Check clapper operation-the clapper should move freely without sticking or binding.
- Replace clapper facings as required.
- Resurface seat rings as required.

4.1.6 Dry pipe Valves and Air Check Valves

Air check valves are special, small, dry pipe valves that are usually connected to a wet pipe system. The alarms are actuated at the wet pipe system riser when the air check valve trips. To prevent premature operation, the valves should be fitted with an air chamber to maintain at least 50 gallons of air in the chamber and on the system.

Perform the 2-inch drain test quarterly by opening the 2-inch drain valve fully and recording the pressure at the lowest point. Close the 2-inch drain valve and record the pressure at the stabilization point. Notice whether pressure returns quickly or slowly. Maintain a continuous record of drain tests.

If the recorded pressure when the valve is wide open is similar to previous recordings and pressure returns quickly, it is normal.

If recorded pressure when the valve is wide open is significantly lower or pressure is slow to return when the valve is closed, there may be an obstruction in the waterway. Check for partially closed valves to the sprinkler system.

Because dry pipe sprinkler systems are installed in areas where temperatures are expected to drop below freezing, all parts of the system must be airtight and kept free of water. Complete drainage is essential.

Each fall, prior to the freezing season, check the pitch of all piping carefully using a spirit level to detect dips and small pockets in the lines. Check for:

- Broken, loose, or missing hangers; and
- Water in low point drains.

Check air and water pressures weekly. If air pressure losses exceed 10 psi, check the entire system for tightness and eliminate air leaks. Principal checking methods are as follows:

- Put a strong-smelling oil, such as oil of peppermint, into the air supply. This will produce a strong odor at the point of leakage.
- Paint fittings with a soapy water solution and watch for bubbles.

Check the temperature of valve enclosure and maintain a temperature above 42°F.

Make certain that the valve between the intermediate chamber and the alarm devices is open on dry pipe valves.

Check drip valves at intermediate chambers, making certain that clappers or balls are in a position to allow drainage. This is done by lifting push rods or by inserting a pencil in the opening. Water leakage through this valve is an indication that the water clapper is not holding tightly to the seat.

Check the air pressure. The air pressure versus water pressure for differential dry pipe valves should be as outlined in *Table 4-3*, unless otherwise specified by the manufacturer's operating instructions. Certain mechanical dry pipe valves are designed to trip at a fixed pressure of 10 to 15 psi. Maintain 30 psi air pressure on these valves.

Table 4-3 – Differential Dry Pipe Valve Air Pressure Specifications.

Maximum water pressure (PSI)	Air pressure range (PSI)
50	15-25
75	20-30
100	25-35
125	30-45
150	35-50

Basic inspections for accelerators and exhausters include the following:

- Check air pressure. The system and the quick-opening device air pressure should be the same.
- Relieve excess pressure in the quick-opening device by opening bleeder valves or loosening air gauges.

If the system pressure is high, relieve the excess pressure through the priming water test valve. Close the valve as soon as pressures balance. To avoid the possibility of tripping the dry pipe valve, do not open the priming test valve more than one turn and keep the valve to the quick-opening device closed while the priming test valve is open.

To make sure that dry pipe valves will operate effectively in fire situations, they should be trip-tested annually as follows:

1. Close the main control valve.
2. Open the 2-inch drain.
3. Open the main control valve until 5 psi pressure shows on the water gauge.
4. Close the 2-inch drain valve slowly.
5. Open the inspector's test connection of the system. Where there is no test connection, use the most remote low point drain.
6. As soon as the dry pipe valve trips, close the main control valve and open the 2-inch drain. This is particularly important in permanently cold areas.
7. Record initial air and water pressures, air pressure at the trip point, and time required for tripping.

8. Examine and clean the dry pipe valve interior. Replace facings and gaskets, if needed.
9. Reset the dry pipe valve and the open control valve.
10. When a dry pipe valve fails to trip or when a clapper fails to latch in the open position, notify the person responsible for fire protection so that a qualified sprinkler contractor may be contacted.

To test dry pipe valves, you should do the following:

1. Close the main control valve and open the 2-inch drain valve and low point drain valves. Close low point drain valves when water stops flowing.
2. Clean clapper facings and seats.
3. Clean the valve interior.
4. Place clappers on seats and make certain the anti-water column latch is in place. Bolt on the cover. Do not use grease or other material to help seat clappers. Fill the system with 10 psi air pressure to blow out any residual water through low point drains.
5. Open valves at the top and bottom of the priming chamber and priming test valves.
6. Admit water to the priming chamber until water flows out of the test valve. Close this valve.
7. Close the priming chamber valves.
8. Admit air pressure to the system.
9. Open the main control valve slowly.
10. Close the main 2-inch drain valve, except where water hammer conditions exist. In this case, leave the 2-inch drain valve open until pressures stabilize.

To check air supply piping, do the following:

- Note air pressure within 12 to 24 hours after resetting the dry pipe valve. If air leakage exists, test sprinkler piping for leaks.
- Make sure the valves to manually operated compressors are tightly closed. A slow air leak back through one of these valves can trip the dry pipe valve.
- Examine restriction orifices in air piping and air pressure regulators, if used, from automatic air compressors to dry pipe valves.

4.1.7 Deluge and Pre Action Valves

To test deluge and pre-action valves, perform the 2-inch drain test quarterly by opening the 2-inch drain valve fully and recording pressure at lowest point. Close the 2-inch drain valve and record pressure at the stabilization point. Notice whether pressure returns quickly or slowly. Maintain a continuous record of drain tests.

If the recorded pressure when the valve is wide open is similar to previous recordings and pressure returns quickly, it is normal.

If the recorded pressure when the valve is wide open is significantly lower or pressure is slow to return when the valve is closed, there may be an obstruction in the waterway. Check for partially closed valves to the sprinkler system. Check the water pressure and the local water flow alarm through the bypass connection.

Some deluge systems have both open and closed sprinklers. Make sure heat-responsive devices are provided in areas with both open and closed sprinklers and are in service. Fusing of a sprinkler will not operate a deluge valve. Where conditions permit, trip-test each deluge valve every 3 years by flowing water through the heads/nozzles. To conduct a deluge valve dry-trip test, do the following:

1. Close the main control valve.
2. Apply an electric heat lamp to at least one heat-actuating device in each circuit, testing one circuit at a time. Note the time required to trip the valve. Where flammable vapors may be present, use a hot cloth or hot water in place of the electric test set.
3. Reset the deluge valve and trip using the manual release.
4. Where fixed temperature releases are involved, wait 15 minutes and trip by removing a fusible element from the tubing or a heat-responsive device.
5. When tests are complete, reset valves and open the main control valves.

Because there are so many designs of heat-responsive devices, test procedures for each device cannot be included here. See the individual manufacturer's information for detailed testing procedures. During routine inspections, check for painted or corroded contacts, plugged vents, or painted domes. Clean or replace affected devices.

4.1.8 Cathodic Protection Equipment

Inspect cathodic protection equipment as follows:

1. While equipment is operating, note and record current flow shown by meters. If there is no current, check for blown fuses, electrodes touching the tank, ground-wire connection to tank, or electrodes not immersed in the water. If equipment operates at voltages or amperages over those listed on the nameplate, the rectifier may be damaged. Check polarity and direction of current flow. (If connections to rectifier are reversed, rapid damage to the tank occurs.)
2. Check condition of electrodes that deteriorate because of action of current passing from electrodes to water. Replace worn electrodes. (Watch for diminishing current flow on the ammeter; this is a sign that the electrodes may be failing.)
3. Protect electrodes from ice. If ice formation is a serious problem, turn off current and remove and store the electrodes during the freezing season. Tank protection will continue for about three weeks after the unit is out of operation. Reinstall the electrodes at the end of the freezing season.

4.1.9 Non-Freeze Systems

No special testing of non-freeze systems is required, other than an annual check of the specific gravity of the non-freeze solution. If the specific gravity indicates a need for replenishing the non-freeze agent, be sure to add the same agent as was previously used.

4.1.10 High Speed Suppression Systems

Full operational testing of high-speed suppression systems is conducted at intervals not to exceed three years, except when mission requirements justify change. A detector or a manual release station must be actuated. Check to be certain that all nozzles are operating. Then, follow these steps to reset the system:

1. Replace pre-prime caps and/or rupture disks.
2. Refill piping with water.
3. If the system uses an explosive valve, replace the firing squib and the squib holder.

4.2.0 Maintenance Requirements

The need for maintenance is shown by periodic inspections. It should include replacement of worn or broken components and cleaning and flushing of systems. A regular schedule of maintenance requirements should be devised. Logs recording accomplished tasks should be maintained as a record of the system's history. Be sure to include manufacturers' manuals for the system components and consult them when making repairs and adjusting or troubleshooting the system.

Test your Knowledge (Select the Correct Response)

2. In a dry-pipe sprinkler system, the entire system should be checked for tightness when air pressure losses exceed what value?
 - A. 20 psi
 - B. 15 psi
 - C. 10 psi
 - D. 5 psi

5.0.0 GASEOUS EXTINGUISHING SYSTEMS

Gaseous extinguishing systems are generally found in areas where equipment is installed that would be highly vulnerable to destruction from water or dry chemical extinguishing agents. Computer rooms, electronic gear such as radio receiving and transmitting equipment, and power-generating facilities are examples of areas where gaseous extinguishing system installation would be desirable. In the Navy today, the Utilitiesman will come in contact with two commonly used systems. These are the carbon dioxide and the halogenated gas systems. Each of these systems is discussed in this section.

Gaseous extinguishing systems can be divided into three general categories: local application; total flooding; and hose line systems.

- Local application systems discharge agent onto the burning material and are commonly used for protection of paint dip tanks, restaurant range hoods, and special motors.
- Total flooding systems discharge agent into and fill enclosed space. They are commonly found in flammable liquid storage rooms, computer installations, and transformer vaults containing oil-filled equipment.
- Hose line systems discharge extinguishing agent through manually operated nozzles connected to a fixed supply by piping and/or hoses. At present, carbon dioxide is the only gaseous agent approved for manual hose line systems.

5.1.0 Carbon Dioxide Systems

There are two general methods of applying carbon dioxide to extinguish a fire. One method creates an inert atmosphere in the enclosure or room where the fire is located for a prolonged period of time. This method is called total flooding. The second method

is to discharge carbon dioxide to the surface of liquids or noncombustible surfaces coated with liquid flammables. This method is known as local application.

Carbon dioxide is electrically nonconductive. It is used extensively for the protection of electrical equipment. The non-damaging quality of this agent makes it useful as an extinguishing agent for computer rooms and computer tape vaults.

There are two general types of carbon dioxide extinguishing systems: high pressure and low pressure.

5.1.1 High Pressure Systems

In the high-pressure system, high-pressure cylinders are used to store liquid carbon dioxide at ambient temperatures (*Figure 4-24*). Normal cylinder pressure is nominally 600 psi and varies with the ambient temperature of the storage area. Storage area ambient temperatures should not exceed 130°F or be less than 32°F. For safety purposes, high-pressure cylinders have a frangible disk that will burst at 3,000 psi to prevent cylinder rupture as a result of over pressurization.

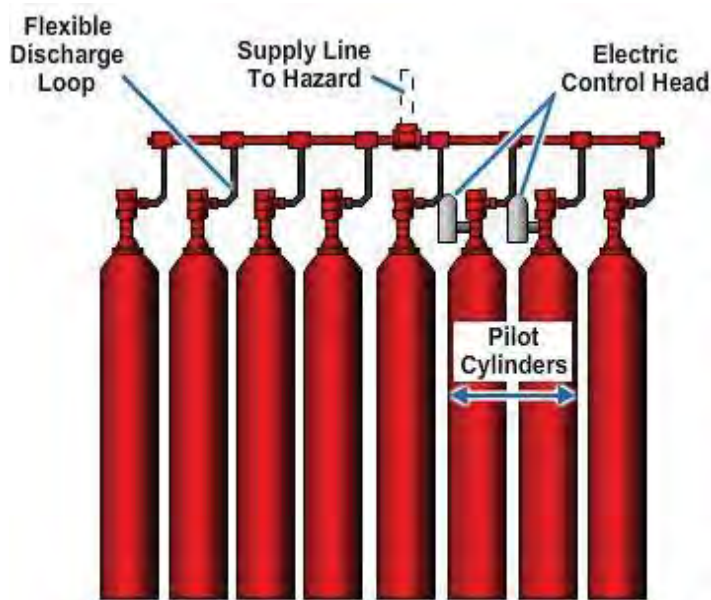

Figure 4-24 - Typical cylinder arrangement for high-pressure CO₂ system.

5.1.2 Low Pressure Systems

Low-pressure systems have a pressure vessel maintained at 0°F by insulation and refrigeration equipment (*Figure 4-25*). At this temperature, the pressure in the container is approximately 300 psi. Because the container is kept at a low temperature, the container can be filled to 90 to 95 percent of capacity. For safety purposes, a relief valve is installed to bleed off pressure at 341 psi. Another relief valve operates at 357 psi for rapid release of excess pressure. There is also a frangible disk designed to burst at 600 psi should the relief valves fail to control pressure buildups.

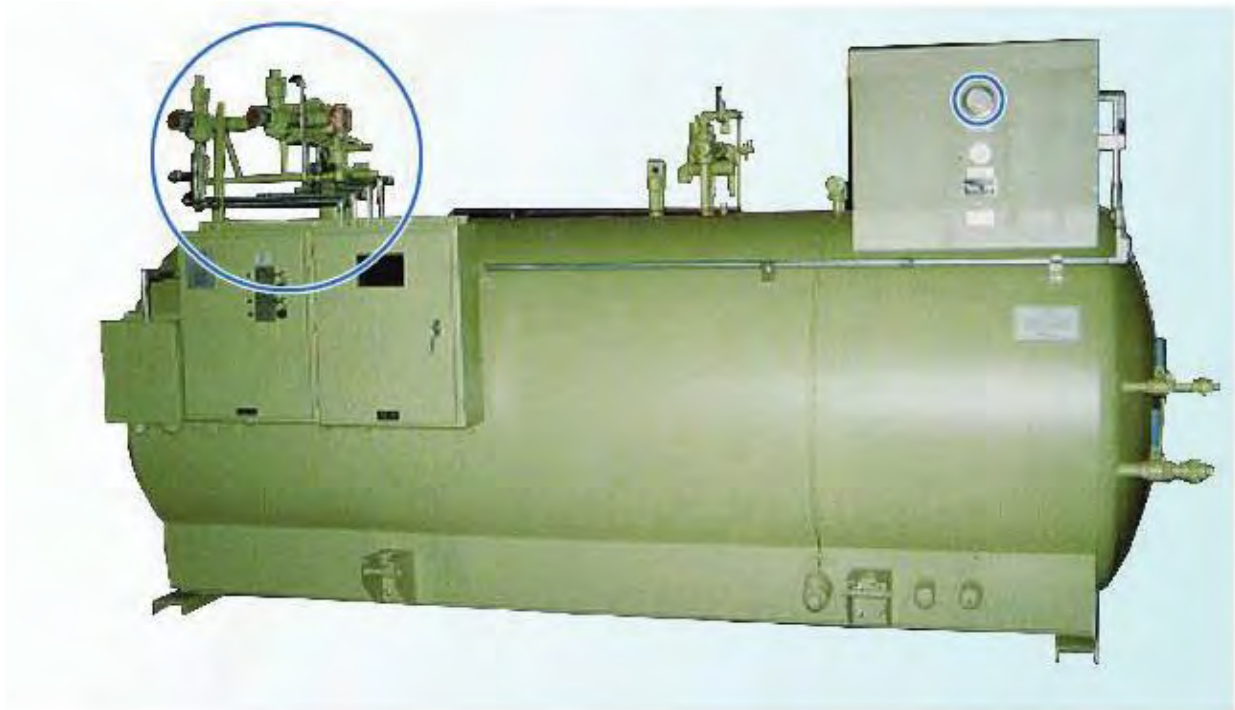

Figure 4-25- Refrigerated low-pressure CO₂ storage tank.

5.1.3 Advantages/Disadvantages of CO₂ Systems

There are advantages and disadvantages to each type of carbon dioxide system.

5.1.3.1 Low Pressure Systems

Low-pressure storage units have a liquid level gauge that continuously monitors the amount of carbon dioxide in storage. The smallest low pressure is 750 pounds. Low-pressure systems do not require hydrostatic testing. Low-pressure systems keep the liquid carbon dioxide at 0°F and 300 psi at all times, assuring a uniform discharge rate. Another advantage of low-pressure systems is their ability to allow automatic, simultaneous discharge for more than one hazard area on an engineered basis. Hose reels can also be attached to these systems to operate simultaneously with hazard protection. A reserve supply can be provided by increasing the storage unit size of low-pressure systems. Usually, low-pressure systems require less floor space for storage of equal amounts of carbon dioxide as compared with high-pressure systems. In many instances, low-pressure storage containers may be placed outside the buildings. Low-pressure systems require one large, single area for the refrigerated storage unit.

5.1.3.2 High Pressure Systems

High-pressure systems require weighing the cylinders. High-pressure systems permit storage of almost the exact amount of carbon dioxide required to protect a hazard area because of the flexibility and selection of cylinders in 50-, 75-, or 100-pound sizes. High-pressure systems require refilling and hydrostatic testing every 12 years. Pressures in

high-pressure systems vary with the ambient temperature; this affects the discharge rate of the system. High-pressure systems require manifolding and valving arrangements to achieve a reserve supply. Storage of the carbon dioxide is also a consideration in showing advantages or disadvantages of these systems. High-pressure systems require approximately 3 pounds of equipment for every pound. High-pressure systems allow flexibility in space requirements because multiple cylinder banks may be stored in several smaller locations.

5.1.4 Operating Devices

As with all fire protection systems, carbon dioxide systems must have operating devices for discharge of the extinguishing agent and to cause alarms to be actuated. Many of the operating devices discussed earlier in this chapter can be used. Most commonly used are the heat-actuated devices (HAD) or smoke detecting devices. Manual controlling devices are also used in carbon dioxide systems. Whether the agent release is automatic or manual, an alarm at the alarm system control unit should be actuated.

5.1.5 Piping

Carbon dioxide fire protection system pipe and fittings are selected to have suitable low temperature characteristics and good corrosion resistance inside and out. Ferrous metals are galvanized steel, copper, brass, and other materials having similar mechanical and physical properties are acceptable. Copper tubing with suitable flared or brazed connections is also acceptable. Cast-iron (gray) pipe and fittings are not used.

Pipe and fittings for high-pressure systems have a minimum bursting pressure of 5,000 psi. In low-pressure systems, pipe and fittings have a minimum bursting pressure of 1,800 psi.

Between the storage tank and selector valves, black steel pipe may be used because of the larger sizes involved and its air tightness.

The supply piping is usually routed to prevent unnecessary exposure to high temperatures from ovens or furnaces or to direct flame impingement before discharge. Hot piping causes excessive vaporization of carbon dioxide and a resultant delay in effective discharge.

Pressure relief devices or valves that prevent entrapment of liquid carbon dioxide may be installed on sections of piping that can be closed off. On high-pressure systems, relief devices usually operate at 2,400 to 3,000 psi, and on low pressure systems at 450 psi.

5.1.6 Nozzles

Nozzles are of various designs and discharge patterns. Two common types are shown in *Figure 4-26*. Nozzles are marked with a code number indicating the diameter in 1/32-inch increments of a single orifice standard nozzle having the same flow rate. A No. 5 nozzle, for example, has the same flow rate as a 5/32-inch diameter standard orifice. A plus sign (+) after the number indicates a 1/64-inch larger size. Decimals are sometimes used to indicate sizes between the whole numbers.

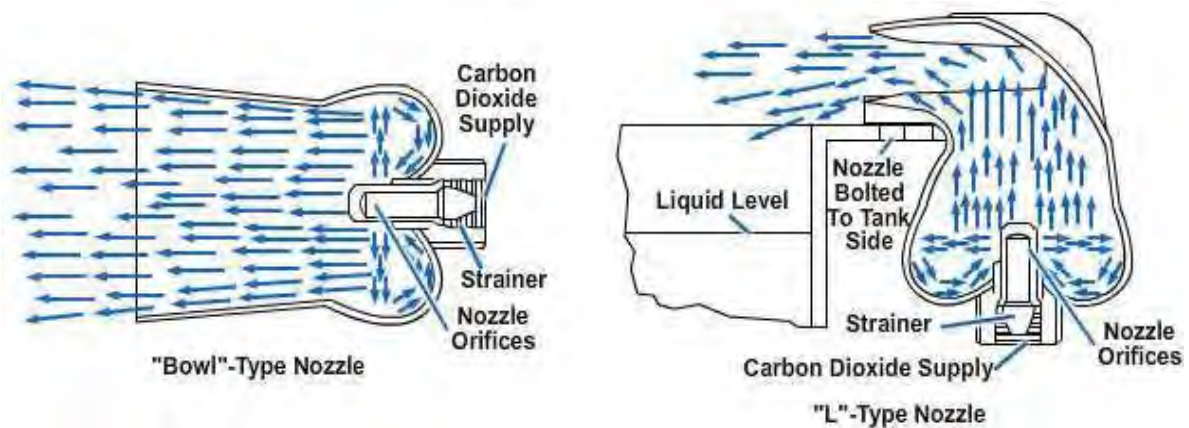

Figure 4-26 – Types of CO₂ nozzles.

5.2.0 Total Flooding Systems

Total flooding systems are used for rooms, ovens, enclosed machines, and other enclosed spaces containing materials extinguishable by carbon dioxide.

To be effective, the space must be reasonably well enclosed so that the gas can displace the oxygen in the room. There are detectors that activate the system and automatic closing devices that close windows, doors, vents, etc., and set off alarms before the system discharges. A typical arrangement of a total flooding carbon dioxide system is shown in *Figure 4-27*.

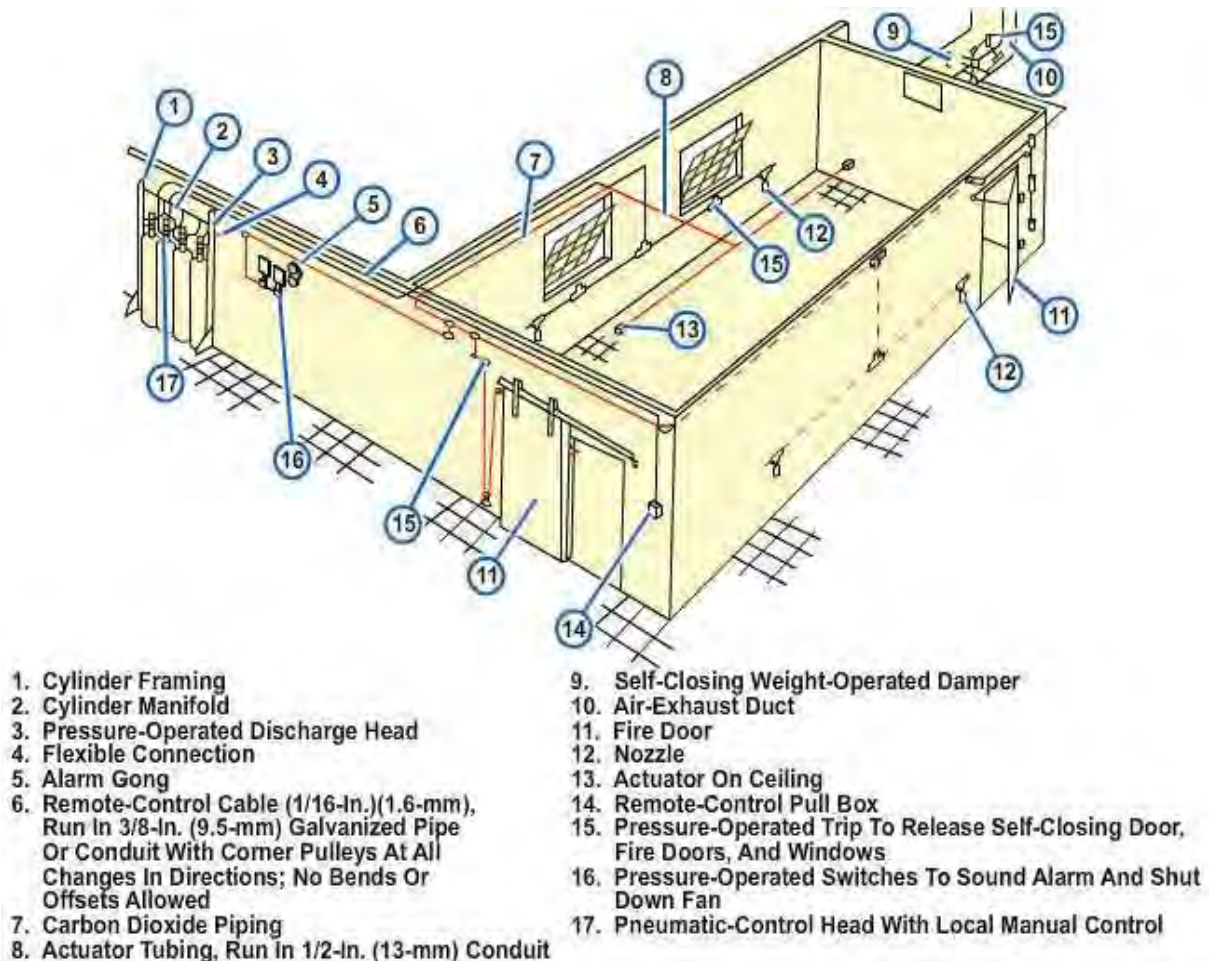

Figure 4-27- CO₂ total flooding system.

5.3.0 Local Application Systems

Local application systems are used to protect hazards, such as oil-filled transformers and paint dip tanks. Ventilating fans, conveyors, flammable liquid pumps, and mixers associated with the operation may be interlocked to shut down automatically when the protection system is activated. A typical arrangement of a local application carbon dioxide system is shown in *Figure 4-28*.

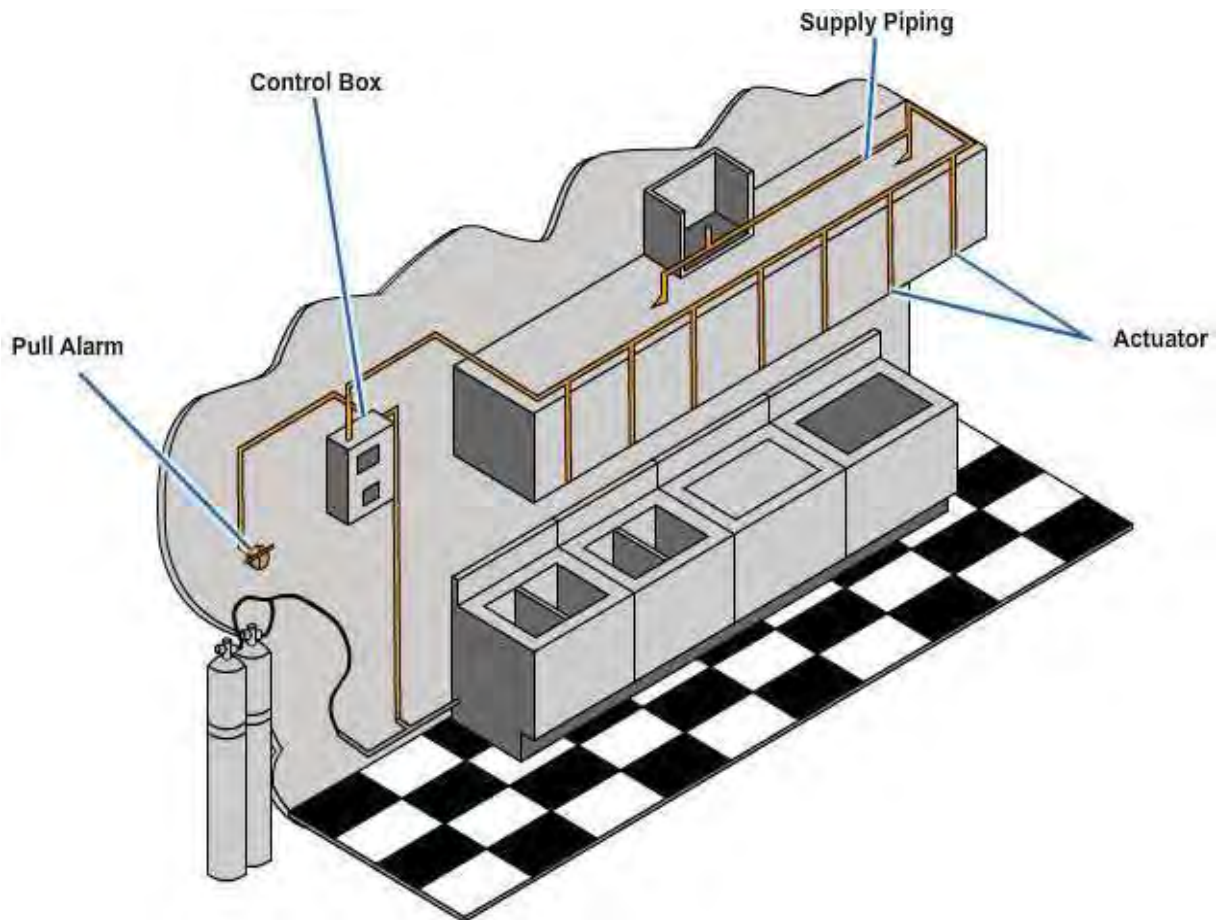

Figure 4-28- Local application of CO₂ system.

5.4.0 Halogenated Gas Systems

Several types of halogenated gas systems have been developed for fire protection purposes: Halon 104; Halon 1001; Halon 1011; Halon 1202; Halon 1211; Halon 1301; and Halon 2402. The numbers relate to the chemical formulas of the gases. The first digit identifies the number of carbon atoms in the chemical molecule; the second digit identifies the number of fluorine atoms; the third digit identifies the number of chlorine atoms; the fourth digit identifies the number of bromine atoms; and a fifth digit, if any, identifies the number of iodine atoms present. Primarily, Halon 1301 and Halon 1211 are in general use in the United States today. These two types are recognized by the National Fire Protection Association (NFPA). Standards for their installation and use are published in the National Fire Codes.

Halogenated gas systems are used in the following situations:

- A clean extinguishing agent is needed.

- Energized electrical or electronic circuits are to be protected.
- Flammable liquids or flammable gases are present.
- Surface-burning combustible solids are to be protected.
- Objects or processes have a high value.
- The area to be protected is occupied by people.
- Availability of water or space for other types of systems is limited.

Generally, Halon 1211 and Halon 1301 are used in total flooding applications.

For effective fire-fighting purposes, a minimum concentration of 5 percent is recommended for total flooding systems for surface fires of ordinary combustibles. Deep-seated fires, as in cable insulation, require much larger concentrations and extended holding times.

Halon 1211 is toxic to people when concentrations exceed 4 percent. This prevents its use as a total flooding agent for areas occupied by personnel. Halon 1211 is normally used in portable extinguishers because it is not in enough concentration to be a hazard for people. Equipment for halon fire extinguishing systems is similar to that used for high-pressure carbon dioxide systems. Halon 1301 is stored in a cylinder super-pressurized with nitrogen to 600 psi (at 70°F) to provide an expellant pressure for the agent in excess of the agent's normal vapor pressure.

Because of the high ozone depletion factor of halons, installation of new Halon 1301 systems is prohibited except by special approval from NAVFACENGCOCM.

Halon 1301 is the least toxic of the halogenated gases and does not harm personnel when concentrations are below 10 percent. Systems that remain in use are located in computer rooms.

5.5.0 Phase Out of Halons

Because of the high ozone depletion potential of CFCs, HCFCs, and halon gases, the EPA enacted the provisions of the Montreal Protocol into regulations for the United States. This enactment eliminated the production of halons in the year 2000. If you are maintaining a system that contains halon gas, consult engineering for information pertaining to system conversion.

5.6.0 Gaseous Extinguishing System Alarms

There are special considerations for gaseous system alarms because of possible toxic effects on personnel, the need for a reasonably fast response, and reliable operation. Response time for gaseous extinguishing agents is not usually as urgent as foam agents, considering the types of hazards protected. Personnel safety precautions also effect the speed requirement. Heat and /or smoke detectors are frequently used as initiating devices.

Cross-zoning is also frequently used for gaseous extinguishing systems. The first detector (zone) actuation is arranged to cause a local audible and/or visual signal. The second detector (zone) actuation causes a distinctive local signal to warn personnel that the extinguishing agent is about to be released.

Some gaseous extinguishing systems, usually those protecting populated spaces, have an abort feature to avoid unnecessary discharge of an expensive, possibly toxic gaseous agent. Extinguishing systems with the abort feature have a time delay between

actuation of the second (or only) detector and release of the agent. The delay may be factory set or adjustable. It is usually set in the range of 15 to 60 seconds, so personnel can leave the area before release of the agent and to allow for manual interruption of the agent release sequence. If the situation is not dangerous, the sequence can be interrupted by a manual abort switch. When the detectors and control unit have been restored to their normal condition, the abort switch can be restored. The abort switch is usually designed to be held in (until the control panel is reset) so that the agent discharge cannot be accidentally impaired when the switch is unattended.

5.6.1 Initiating Devices

Frequently used detectors for gaseous agents are spot-type ionization smoke detectors and rate-compensated heat detectors. Factors affecting detector effectiveness, such as electrical power and air pressure, if pertinent, are supervised.

One or two manual methods for release of the gaseous agent are usually provided.

Manual fire alarm devices are frequently connected to the alarm system control unit to cause immediate discharge of the gaseous agent, regardless of cross-zoning and time delays otherwise provided.

Manual devices may also be connected electrically to cause direct release of the agent, independent of the alarm system.

Direct mechanical release of agent may be by manual actuation of a control valve.

Whether the agent release is caused by an alarm control unit auxiliary output or by an independent manual method, there should be an alarm at the alarm system control unit. Manual release of the gaseous agent usually causes an alarm by actuating a pressure switch that senses the increase in pressure in the gas line or manifold between the release valve(s) and the nozzles.

5.6.2 Sequence of Alarms

The normal circuit arrangement for a building alarm system to release a gaseous extinguishing agent is the same as for a building system with added features, such as cross-zoning, the abort feature, manual release of agent, and other specific auxiliary functions of the alarm system. Alarm systems that release a gaseous extinguishing agent use auxiliary alarm outputs to segregate the protected area and reduce dispersion and dilution of the agent. Typical auxiliary functions are fan shutdown, door (and window) closure, and closure of air-handling system dampers. Gaseous agent-releasing alarm systems applied to computer room installations also shut down computer power at the time the agent is released to eliminate the heat source for possible electrical fires.

A typical sequence of alarm system-initiated events in a computer room installation that includes all the usual features is as follows:

- Detection of fire by first detector in an area causes local and remote alarm indication, fan shutdown, door and damper closure, and other miscellaneous auxiliary functions through interlocks with building systems.
- Detection of fire by second detector in the area (cross-zoned with first detector) causes a distinctive, local, audible signal and initiates a time delay, during which agent release and computer power shutdown may be aborted.

- At the end of an adjustable delay (normally 20 seconds), assuming the release is not aborted, computer power is shut down and the extinguishing agent is released into the protected area.

5.7.0 Inspection, Testing, and Maintenance of Gaseous Systems

Inspection, testing, and maintenance of gaseous fire extinguishing systems are required to be sure they are in proper operating order. Inspection and test frequencies for these systems are summarized in *Table 4-4*.

Table 4-4 – Summary of inspection and test frequencies for gaseous systems.

	Weekly	Monthly	Semi-Annually	Annually
Check CO ₂ and Halon nozzles and hand hose lines	X			
Weigh cylinders			X	
Check liquid level in low-pressure CO ₂ storage tanks	X			
Check devices and connections of low-pressure CO ₂ systems for leakage		X		
Test tank alarm pressure switch and identification device			X	
Conduct actuating and operating tests of CO ₂ and Halon system cylinders				X
Hydrostatic test of cylinders and hoses				1
1- See text below for frequency				

5.7.1 Carbon Dioxide High-Pressure Systems

Check hoses and nozzles, cylinders, and cylinder pressure as follows:

- Weekly, check that all nozzles and hand hose lines are clear and in the proper position and that all operating controls are properly set.
- Semiannually, weigh cylinders and replace any that show a weight loss of greater than 10 percent. To weigh cylinders, do the following:
 - Loosen each cylinder support and disconnect each discharge head. Discharge heads are designed to be removed and replaced without tools.
 - Weigh cylinders with a beam scale or with a platform scale. To weigh with a platform scale, remove the cylinders completely from the rack and lift them onto the scale.

Test cylinders and hoses hydrostatically as follows:

- Hydrostatically test cylinders to a minimum pressure of 3,000 psi. The frequency for testing is as follows:
 - If discharged after 5 years from date of last test, perform hydrostatic test.
 - If not discharged after 12 years from date of last test, discharge cylinder and perform hydrostatic test.
- Hydrostatically test hoses to a minimum pressure of 1,250 psi. The frequency of testing is the same as for cylinders.

5.7.2 Carbon Dioxide Low Pressure Systems

Check nozzles, pressure and level gauges, and the system for leaks in all devices:

- Weekly, check to see that all nozzles are clear and in the proper position and that all operating controls are properly set. Check and record the reading on the liquid level gauge of all storage tanks. Refill tanks when the quantity is less than the minimum required to protect the largest single hazard, including any required reserve supply.
- Monthly, check for leaks on all devices and connections under continuous pressure, including valve packing glands, screwed connections, and safety relief valves.
- Semiannually, test the tank-alarm pressure switch and the operation of the alarm bell or light by reducing and increasing the pressure. Perform this test as follows:
 - Close valve on the piping from the vapor space to the alarm pressure switch.
 - Remove the test plug to reduce pressure.
 - Increase pressure by connecting a high-pressure cylinder to the test opening.
 - After testing, disconnect the high-pressure cylinder, replace the test plug, and reopen the valve on the alarm pressure switch piping.
 - If the bell or light fails to operate on the pressure test, repair or replace, and test again.
- Check the liquid level and pressure gauges for accuracy once each year.
- Replace frangible disks on the storage tanks once every 5 years. Maintain refrigeration equipment according to the manufacturer's instructions.

5.7.3 Halogenated Systems

Follow these procedures to test halogenated systems:

- Weekly, check to see that all nozzles are clear, positioned properly and all operating controls are set properly.
- Semiannually, check weight and pressure containers. (See procedures for verifying CO₂ cylinders.) If the container has a loss in net weight of more than 5 percent or a loss in pressure (after adjusting for temperature) of more than 10 percent, you must either refill or replace the container. When a factory-charged, non-refillable container does not have a pressure indicator that shows a loss in net weight of more than 5 percent, you must replace the container.
- Annually, test all actuating and operating devices. Use a cylinder containing carbon dioxide in the place of a halon cylinder or perform a simulated test of pressure-operated devices.

5.7.4 Alarm Systems

You should perform tests and maintenance of detectors, circuits, control units, annunciators, relays, and power supplies as described in *Maintenance of Fire Protection Systems*, NAVFAC MO-117, chapter 3. Some additional steps are required to test cross-zoned detectors, electrically operated releases for gaseous agents, and an abort feature.

5.7.5 Release Devices and Auxiliary Functions

Test electrically operated release devices for gaseous extinguishing systems annually. Combine this test with tests of detectors and the total alarm system. If you cannot perform an actual discharge test, be sure to prevent gas discharge and computer power shutdown, if provided, while observing electrical functions. This may require valve closure or partial disassembly of diaphragm piercing, solenoid plunger-type valves, and manual override of the computer shutdown feature. Refer to system instructions from the equipment manufacturer or installing company. The same method, once determined, is normally used for testing manual devices connected electrically to cause direct actuation of gas release devices. After taking necessary steps to prevent gaseous discharge, you should cause the necessary alarm conditions to activate the extinguishing system by actuating the detectors or manual initiating devices. At the end of the time delay intend, release device actuation should be evident. Verify that relays for auxiliary functions actuate. Take notes on which event relays actuate at the first cross-zoned detector alarm, second cross-zoned detector alarm, and at the end of the timer intend. Note the amount of time delay between the second detector actuation and the delayed functions.

If release devices or auxiliary functions fail, you should replace the control unit in the alarm condition and check appropriate output voltages at the control unit and at the failed device. If voltages are improper, troubleshoot the control unit or circuit as indicated. Cross-zoned systems require an alarm condition on both initiating circuits to actuate release devices and some auxiliary functions. If a timed function fails, check input voltage to the timer and the delayed output voltage from the timer with a voltmeter. Replace the timer if input is proper but output is not. If voltages are proper, check solenoid and relay coil continuities with one side of their respective energizing circuits open to the control unit. (See testing and maintenance for foam systems, *Maintenance of Fire Protection systems*, NAVFAC MO-117, section 7.3.1.) Replace defective devices and/or wiring.

5.7.6 Abort Feature

In gaseous extinguishing systems with an abort feature, test the feature annually along with the other elements of the system. To test the abort feature, first determine the timer setting from prior test records or installation data. Then cause first and second cross-zoned detect or alarms. The second detector alarm starts the timed period during which the gaseous agent release and other abortable functions may be activated. Operate the abort switch approximately in the middle of the time interval. Perform this test with the agent release and computer shutdown features disabled. At the end of the time interval, confirm that the aborted functions do not occur. Possible causes of abort failure:

- A defective abort switch,
- A defect in the wiring between the abort switch and the main control unit, or
- An improper abort feature installation or an improper timer setting (low).

During troubleshooting, disable the extinguishing agent release and the computer shutdown feature, if provided. Check the abort timer setting according to the manufacturer's instructions. If the timer setting is quite low (15 seconds or less) increase the setting to 20 seconds or more (as determined by local authorities to be adequate to prevent unnecessary discharge of the agent).

If actuating the abort switch has no effect, check the switch continuity with an ohmmeter while actuating it disconnected from its wiring. If the switch continuity shows alternating

readings of zero ohms and infinite resistance, as it should when being repeatedly actuated, check that the OFF and ON positions of the switch are not reversed. (Such reversal may be caused by connecting the wires to the wrong pair of switch terminals or inverting the switch when mounting it.) If the switch has no defect, check its circuit continuity with an ohmmeter at the control unit and with at least one wire disconnected from the control unit. Observe switch action at the ohmmeter by actuating the switch repeatedly. Correct any circuit defects or wiring errors. Replace the switch if it is defective.

Test your Knowledge (Select the Correct Response)

3. Gaseous extinguishing systems are normally located in which of the following areas?
 - A. Computer operation centers
 - B. Radio receiver buildings
 - C. Power generating facilities
 - D. Each of the above

6.0.0 Dry Chemical Extinguishing Systems

Dry chemical extinguishing systems are very similar in construction and operation to gaseous extinguishing systems. There are three general categories of chemical extinguishing systems: total flooding, local application, and hose line systems.

Total flooding systems are arranged to discharge the agent into enclosed spaces. Such systems are used for the protection of flammable liquid storage rooms and paint drying ovens (*Figure 4-29*). Ventilating equipment, conveyors, flammable liquid pumps, and mixers may be interlocked with the dry chemical system and arranged to shut down automatically upon discharge of the system.

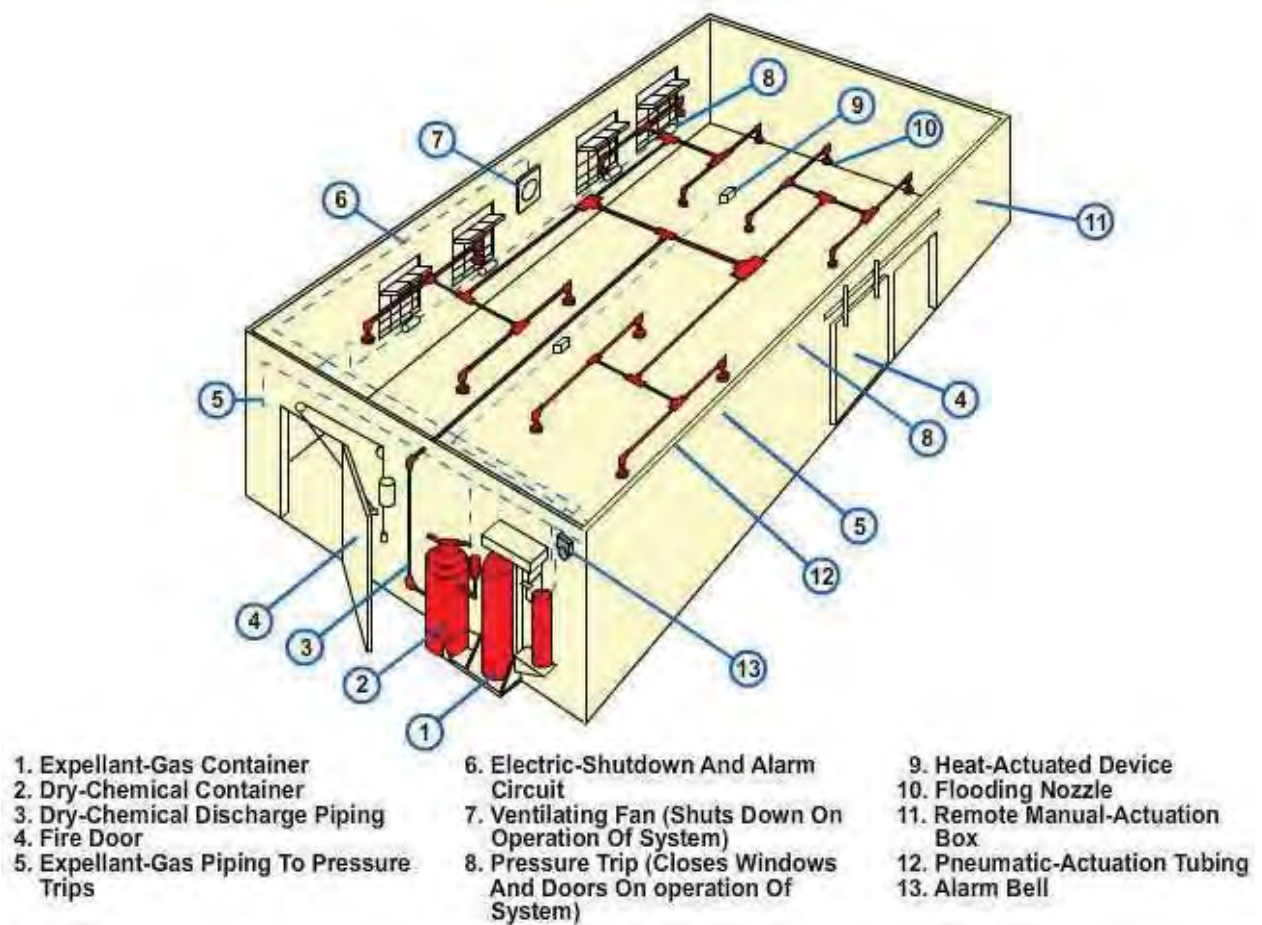

Figure 4-29- Total flooding dry chemical system installation.

Local application systems are arranged to discharge dry chemical directly on the hazard, without any enclosure (*Figure 4-30*). Typical local application systems are used for the protection of paint dip tanks and restaurant range hoods. Ventilating fans, conveyors, flammable liquid pumps, and mixers may be interlocked to shut down automatically upon discharge of the system.

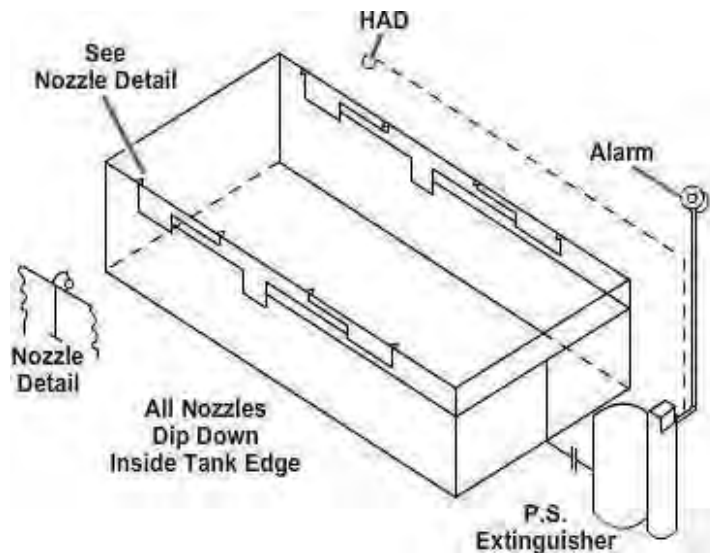

Figure 4-30 – Local application of a dry chemical system installation.

Hose line systems discharge dry chemical through manually operated nozzles connected by hose or by piping and hose to a fixed supply (*Figure 4-31*).

Dry chemical used in approved systems is mostly sodium bicarbonate, very finely ground, to which other ingredients have been added to keep it free flowing and to resist caking. Other agents used in dry chemical extinguishing systems include potassium bicarbonate, potassium chloride, and monoammonium phosphate-multipurpose type.

The dangers dry chemicals used in fire extinguishing concentrations cause exposed personnel are temporary breathing difficulty and reduced visibility. In areas using total flooding systems, suitable means should be provided to permit evacuation of personnel. In areas using local application systems where the dry chemical is not confined, there is little hazard to personnel.

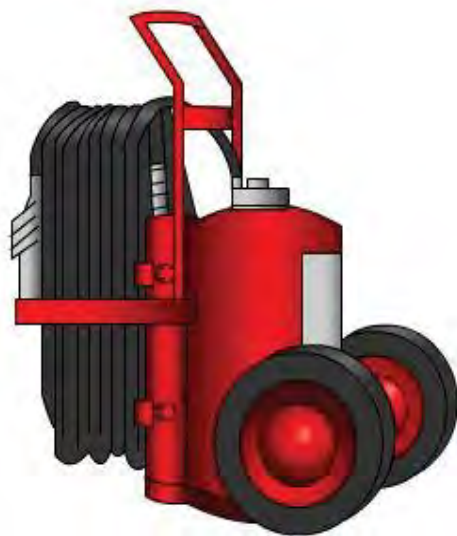

Figure 4-31 – Dry chemical cylinder with a hose.

Dry chemical systems are used primarily for extinguishing fires in flammable liquids. Bicarbonate base dry chemical can be particularly effective for extinguishing fire in deep fat fryers caused by overheating. The saponification reaction between the dry chemical and fat or grease prevents re-ignition by turning the fat to soap. Multipurpose dry chemical will not react with the fat or grease and can prevent the saponification reaction between the fat or grease and any bicarbonate base dry chemical subsequently used.

Dry chemical systems are not suitable for fires in materials that contain their own oxygen supply, such as cellulose nitrate. They are not normally used for fires involving delicate electrical equipment, such as telephone switchboards, computers, and certain other electronic equipment, because the dry chemical will insulate the fine and delicate contacts. The contacts will then need complete cleaning.

Monoammonium phosphate and potassium chloride are slightly acidic and, in the presence of moisture, can corrode metals, such as steel, cast iron, aluminum bronze, and titanium. Corrosion can be minimized by prompt cleanup. Most dry chemical agents can be cleaned up by wiping, vacuuming, or washing the exposed materials or surfaces. Monoammonium phosphate will require some scraping and washing if exposed surfaces were hot when the agent was applied.

6.1.0 Types of Systems

There are basically two types of dry chemical systems:

- Gas cartridge systems that use a container of expellant gas that, when released by manual or automatic means, pressurize the container of dry chemical and force the agent through the piping network or hose lines (*Figure 4-32*)
- Stored pressure systems that consist of a container of dry chemicals that is constantly pressurized, usually with nitrogen

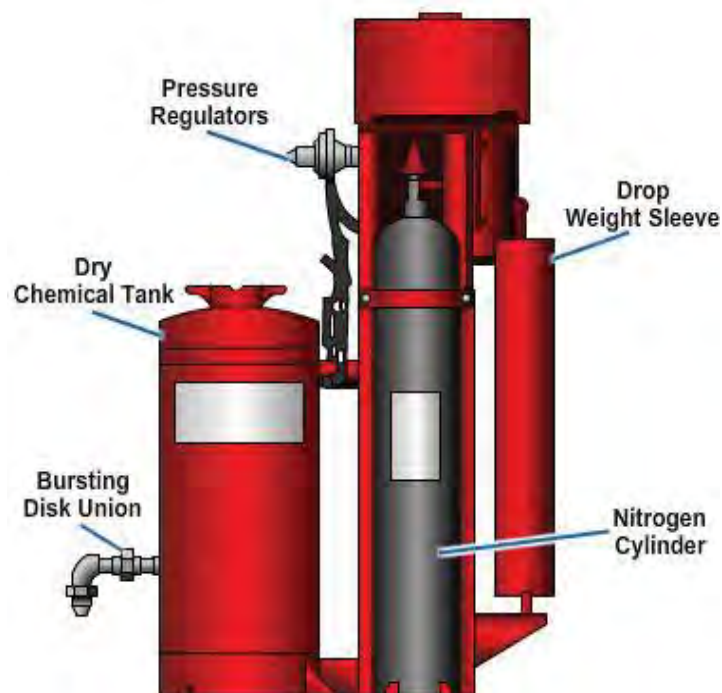

Figure 4-32 – Dry chemical and expellant gas storage cylinder.

6.2.0 System Components

Operating devices are used to release the expellant gas from its container for the pressurization of the dry chemical tank or to release the dry chemical if it is stored under pressure.

In fixed systems, expellant gas is released from its container by electrically, pneumatically, or mechanically dropping a weight that opens a cylinder valve or by mechanically releasing a spring that punctures the sealing disk of a gas cartridge. The dry chemical when stored under pressure is released by pneumatically or mechanically dropping a weight that opens the discharge valve. Pressure trips may be used to release the weights of more than one unit for simultaneous discharge of expellant gas. Pressure trips are operated by gas pressure taken from the low-pressure side of the expellant gas regulator.

Hose line systems are actuated at the cylinder by turning a hand wheel or by moving a lever.

The distribution system (piping) should be constructed of standard weight (schedule 40), galvanized steel pipe and standard weight, galvanized steel or malleable iron fittings.

It is important for the piping system to be balanced so the pressure drop to any one nozzle is about the same as to any other nozzle. Although dry chemical suspended in a gas may be homogeneous during flow, certain effects, such as inertia and sudden expansion of the gas, may cause some separation of the two phases. For example, if several nozzles are installed consecutively at right angles to a straight run of pipe, the inertia of the dry chemical carries most of it past the first nozzles. Therefore, these nozzles discharge more gas and less dry chemical than those farther down the piping system. To eliminate this, you can balance all branch piping by the use of tees (the dry chemical enters the side port and leaves through the two end ports).

Nozzles have various designs and discharge patterns. Nozzles used for distributing the dry chemical must be approved for a particular application.

Test your Knowledge (Select the Correct Response)

4. What type of gas is used as a propellant for a dry chemical system?
- A. Hydrogen
 - B. Oxygen
 - C. Nitrogen
 - D. Carbon dioxide

Summary

Fire suppression systems are designed to extinguish fires as quickly as possible to prevent the loss of lives and property. If the components of these systems are not functioning properly, extensive damage or loss of life could occur. You learned how to inspect and maintain many of these systems. If needed, you may have to repair some or all of the components involved to operate properly, and possibly save lives. Although as a Utilitiesman it may not be your direct tasking or responsibility to install or maintain fire suppression systems, it is important to understand the science and operation of these systems, You may be called upon to advise the chain of command on installation or operation capabilities of the plumbing system and like materials.

Trade Terms Introduced In This Chapter

Clapper	An assembly inside the alarm check valve that prevents the flow of water when closed
Priming water	A small amount of water over the clapper valve to ensure a tight seal
Accelerator	A device that allows air from the fire system to escape and open the clapper
Exhauster	A device that opens and helps to exhaust the air from the piping system faster, enabling a shorter reaction time to activate the suppression system
Fire flow demand	The water needed to for fire-fighting equipment to sufficiently suppress a fire

Additional Resources and References

This chapter is intended to present thorough resources for task training. The following reference works are suggested for further study. This is optional material for continued education rather than for task training.

Basic Machines, NAVEDTRA 12199, Naval Education and Training Professional Development and Technology Center, Pensacola, FL, 1994.

OSHA Regulations (Standards -29 CFR)

Naval Construction Force Manual, NAVFAC P-315, Naval Facilities Engineering Command, Washington, D.C., 1985.

Engineering Aid Basic, NAVEDTRA 10696-A, Naval Education and Training Professional Development and Technology Center, Pensacola, FL, 1995.

Facilities Planning Guide, NAVFAC P-437, Volumes 1 and 2, Naval Facilities Engineering Command, Alexandria, VA, 1982.

Fluid Power, NAVEDTRA 12964, Naval Education and Training Professional Development and Technology Center, Pensacola, FL, 1994.

National Standard Plumbing Code-Illustrated, National Association of Plumbing-Heating-Cooling Contractors, Washington, DC, 2006.

Plumbing Manual, Volume II, NTTTC Course 140-B, NAVFAC P-376, NAVFAC Technical Training Center, Navy Public Works Center, Norfolk, VA, 1965.

Safety and Health Requirements Manual, EM-385-1-1, Department of the Army, U.S. Army Corps of Engineers, Washington, DC, 1992.